

# Pressfittingsysteme Preisliste 2024



inoxPRES®

inoxPRES® UNIKO®

steelPRES®

inoxPRES® 304L

**RIM**  
RACCORDERIE METALLICHE

---

**1** Sanitär  
inoxPRES, inoxPRES UNIKO

---

**2** Heizung  
steelPRES

---

**3** Kälte  
inoxPRES

---

**1**

**2**

**3**





Sanitär  
inoxPRES  
inoxPRES UNIKO

1



**Edelstahlrohre INOXPRES 116/030**

- Für Trinkwasser, Sanitär und Industrieanwendungen
- Material: AISI 444 - 1.4521
- Norm: EN 10217-7 (DIN 17455) - EN 10312
- SVGW Nr.: 0007 - 4278
- SVGW Nr.: 1911 - 6889



Abmessungen mm	Innen-Ø mm	Länge m	Volumen l / m	Orig. Nr.	☒ m	Art.-Nr.	CHF m
15 x 1	13	6	0.133	116015030	60	448100100	9.15
18 x 1	16	6	0.201	116018030	60	448100110	10.55
22 x 1.2	19.6	6	0.302	116022030	60	448100120	15.20
28 x 1.2	25.6	6	0.514	116028030	30	448100130	19.55
35 x 1.5	32	6	0.804	116035030	30	448100140	29.45
42 x 1.5	39	6	1.194	116042030	30	448100150	35.80
54 x 1.5	51	6	2.042	116054030	30	448100160	45.90
							4481

**Edelstahlrohre INOXPRES 116/200**

- Für Trinkwasser, Sanitär-, Gas- und Industrieanwendungen
- Material: AISI 316L - 1.4404
- Norm: EN 10217-7 (DIN 17455) - EN 10312
- SVGW Nr.: 0007 - 4278
- SVGW Nr.: 1911 - 6889

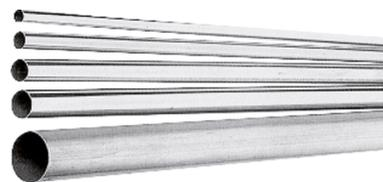

Abmessungen mm	Innen-Ø mm	Länge m	Volumen l / m	Orig. Nr.	☒ m	Art.-Nr.	CHF m
15 x 1	13	6	0.133	116015200	60	448000100	14.15
18 x 1	16	6	0.201	116018200	60	448000110	16.10
22 x 1.2	19.6	6	0.302	116022200	60	448000120	22.45
28 x 1.2	25.6	6	0.514	116028200	30	448000130	28.30
35 x 1.5	32	6	0.804	116035200	30	448000140	42.80
42 x 1.5	39	6	1.194	116042200	30	448000150	51.10
54 x 1.5	51	6	2.042	116054200	30	448000160	65.65
							4480

**Edelstahlrohre INOXPRES 116/200 King Size Inox**

- Für Trinkwasser, Sanitär-, Gas- und Industrieanwendungen
- Material: AISI 316L - 1.4404
- Norm: EN 10217-7 (DIN 17455) - EN 10312
- SVGW Nr.: 0007 - 4278
- SVGW Nr.: 1911 - 6889

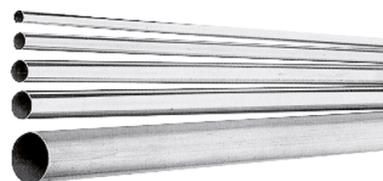

Abmessungen mm	Innen-Ø mm	Länge m	Volumen l / m	Orig. Nr.	☒ m	Art.-Nr.	CHF m
76.1 x 2	72.1	6	4.080	116076200	6	448400100	117.90
88.9 x 2	84.9	6	5.660	116088200	6	448400110	136.50
108 x 2	104	6	8.490	116108200	6	448400120	167.90
							4484

**Edelstahlrohre INOXPRES 116 Oversize Inox**

- Für Trinkwasser, Sanitär-, Gas- und Industrieanwendungen
- Material: AISI 316L - 1.4404
- Norm: EN 10217-7 (DIN 17455) - EN 10312
- DVGW Nr.: DW-8511AV2084



Abmessungen mm	Innen-Ø mm	Länge m	Volumen l / m	Orig. Nr.	☒ m	Art.-Nr.	CHF m
139.7 x 2**	135.7	6	14.460	116139200	6	448600100	267.25
139.7 x 2.6	134.5	6	14.208	116139260	6	448600110	474.80
168.3 x 2**	164.3	6	21.200	116168200	6	448600120	293.25
168.3 x 2.6	163.1	6	20.893	116168260	6	448600130	553.90
							4486

\*\*Nicht DVGW zertifiziert

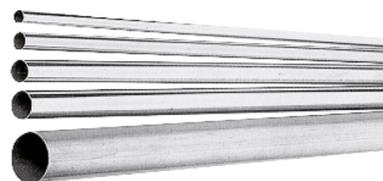



### Bögen INOXPRES 181/150 Inox M-Profil

- Material: AISI 316L - 1.4404
- O-Ring: EPDM schwarz / I/I
- SVGW Nr.: 0007 - 4278



d mm	Winkel °	Z mm	L mm	Orig. Nr.	Stück	Art.-Nr.	CHF Stück
15	15	10	30	181015150	20	448200100	12.20
18	15	12	32	181018150	20	448200110	13.50
22	15	12	33	181022150	20	448200120	15.70
28	15	13	36	181028150	10	448200130	18.90
35	15	11	37	181035150	10	448200140	24.20
42	15	12	42	181042150	4	448200150	34.95
54	15	12	49	181054150	2	448200160	44.85
							4482



### Bögen INOXPRES 181/150 King Size Inox M-Profil

- Material: AISI 316L - 1.4404
- O-Ring: EPDM schwarz / I/I
- SVGW Nr.: 0007 - 4278



d mm	Winkel °	Z mm	L mm	Orig. Nr.	Stück	Art.-Nr.	CHF Stück
76.1	15	32.5	87.5	181076150C	2	448500100	146.40
88.9	15	40.5	100.5	181088150C	2	448500110	174.45
108	15	34.5	109.5	181108150C	2	448500120	237.85
							4485



### Bögen INOXPRES 181/151 Inox M-Profil

- Material: AISI 316L - 1.4404
- O-Ring: EPDM schwarz / I/A
- SVGW Nr.: 0007 - 4278



d mm	Winkel °	Z mm	H mm	L mm	Orig. Nr.	Stück	Art.-Nr.	CHF Stück
15	15	10	40	30	181015151	20	448200170	12.20
22	15	12	41	33	181022151	20	448200190	14.80
28	15	13	43	36	181028151	10	448200200	17.60
35	15	11	41	37	181035151	10	448200210	22.55
42	15	12	55.5	42	181042151	4	448200220	33.65
54	15	13	55	49	181054151	2	448200230	43.15
							4482	

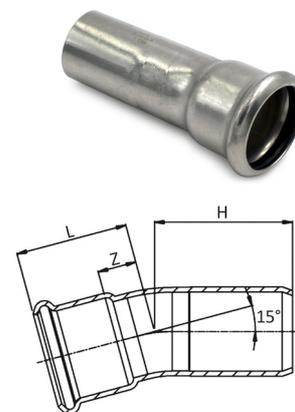

### Bögen INOXPRES 181/151 King Size Inox M-Profil

- Material: AISI 316L - 1.4404
- O-Ring: EPDM schwarz / I/A
- SVGW Nr.: 0007 - 4278



d mm	Winkel °	Z mm	H mm	L mm	Orig. Nr.	Stück	Art.-Nr.	CHF Stück
76.1	15	32.5	95.5	87.5	181076151C	2	448500130	134.30
88.9	15	40.5	108.5	100.5	181088151C	2	448500140	160.35
108	15	34.5	118	109.5	181108151C	2	448500150	219.00
							4485	



**Bögen INOXPRES 181/300 Inox M-Profil**

- Material: AISI 316L - 1.4404
- O-Ring: EPDM schwarz/ I/I
- SVGW Nr.: 0007 - 4278

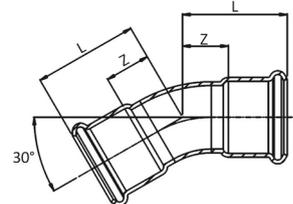

d mm	Winkel °	Z mm	L mm	Orig. Nr.	Stück	Art.-Nr.	CHF Stück
15	30	13	33	181015300	20	448200310	12.20
18	30	12	32	181018300	20	448200320	13.50
22	30	16	37	181022300	20	448200330	15.70
28	30	18	41	181028300	10	448200340	18.90
35	30	11	37	181035300	10	448200350	24.20
42	30	14	44	181042300	4	448200360	34.95
54	30	17	52	181054300	2	448200370	44.85
							4482

**Bögen INOXPRES 181/150 King Size Inox M-Profil**

- Material: AISI 316L - 1.4404
- O-Ring: EPDM schwarz/ I/I
- SVGW Nr.: 0007 - 4278

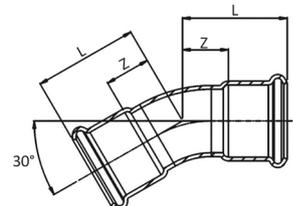

d mm	Winkel °	Z mm	L mm	Orig. Nr.	Stück	Art.-Nr.	CHF Stück
76.1	30	55	100	181076300	2	448500190	146.40
88.9	30	64	115	181088300	2	448500200	174.45
108	30	68	127	181108300	2	448500210	237.85
							4485

**Bögen INOXPRES 181/301 Inox M-Profil**

- Material: AISI 316L - 1.4404
- O-Ring: EPDM schwarz/ I/A
- SVGW Nr.: 0007 - 4278

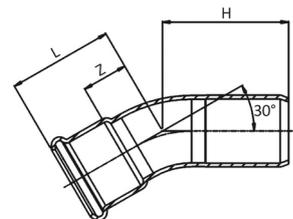

d mm	Winkel °	Z mm	H mm	L mm	Orig. Nr.	Stück	Art.-Nr.	CHF Stück
15	30	13	43	33	181015301	20	448200380	12.20
22	30	16	46	37	181022301	20	448200400	14.80
28	30	18	48	41	181028301	10	448200410	17.60
35	30	11	46	37	181035301	10	448200420	22.55
42	30	14	54	44	181042301	4	448200430	33.65
54	30	17	63	52	181054301	2	448200440	43.15
							4482	

**Bögen INOXPRES 181/301 King Size Inox M-Profil**

- Material: AISI 316L - 1.4404
- O-Ring: EPDM schwarz/ I/A
- SVGW Nr.: 0007 - 4278



d mm	Winkel °	Z mm	H mm	L mm	Orig. Nr.	Stück	Art.-Nr.	CHF Stück
76.1	30	55	108	100	181076301	2	448500220	134.30
88.9	30	64	123	115	181088301	2	448500230	160.35
108	30	68	136	127	181108301	2	448500240	219.00
							4485	

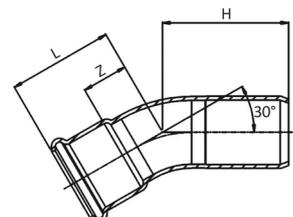



### Bögen INOXPRES 181/450 Inox M-Profil

- Material: AISI 316L - 1.4404
- O-Ring: EPDM schwarz/ I/I
- SVGW Nr.: 0007 - 4278



d mm	Winkel °	Z mm	L mm	Orig. Nr.	Stück	Art.-Nr.	CHF Stück
15	45	7.5	27.5	181015450C	20	448200520	10.75
18	45	9.5	29.5	181018450C	20	448200530	11.90
22	45	11	32	181022450C	20	448200540	13.80
28	45	14	37	181028450C	10	448200550	16.65
35	45	17	43	181035450	10	448200560	19.70
42	45	21	51	181042450	4	448200570	31.85
54	45	30	62	181054450	2	448200580	40.90
							4482

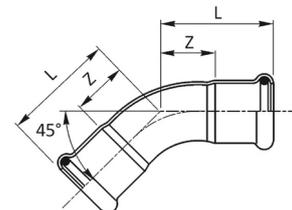

### Bögen INOXPRES 181/450 King Size Inox M-Profil

- Material: AISI 316L - 1.4404
- O-Ring: EPDM schwarz/ I/I
- SVGW Nr.: 0007 - 4278



d mm	Winkel °	Z mm	L mm	Orig. Nr.	Stück	Art.-Nr.	CHF Stück
76.1	45	76.5	131.5	181076450	2	448500280	119.85
88.9	45	84	144	181088450	2	448500290	142.85
108	45	94	169	181108450	2	448500300	194.75
							4485

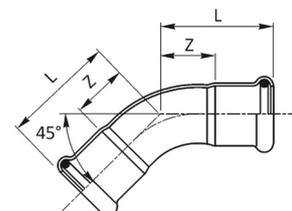

### Bögen INOXPRES 181/450 Oversize Inox M-Profil

- Material: AISI 316L - 1.4404
- O-Ring: EPDM schwarz/ I/I
- DVGW Nr.: DW-8511AV2084



d mm	Winkel °	Z mm	L mm	Orig. Nr.	Stück	Art.-Nr.	CHF Stück
139.7	45	108	203	181139450	1	448700100	546.55
168.3	45	139	252	181168450	1	448700110	708.65
							4487

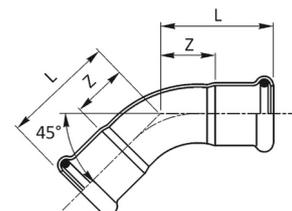

### Bögen INOXPRES 181/451 Inox M-Profil

- Material: AISI 316L - 1.4404
- O-Ring: EPDM schwarz / I/A
- SVGW Nr.: 0007 - 4278



d mm	Winkel °	Z mm	H mm	L mm	Orig. Nr.	Stück	Art.-Nr.	CHF Stück
15	45	7.5	36	27.5	181015451C	20	448200590	10.75
18	45	9.5	38	29.5	181018451C	20	448200600	11.55
22	45	11	42	32	181022451C	20	448200610	13.05
28	45	14	46	37	181028451C	10	448200620	15.55
35	45	17	57.5	43	181035451	10	448200630	18.30
42	45	21	72	51	181042451	4	448200640	30.65
54	45	26	82	62	181054451	2	448200650	39.30
							4482	

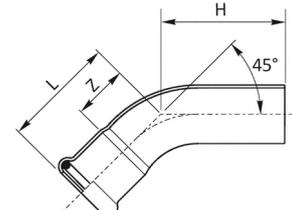

**Bögen INOXPRES 181/451 King Size Inox M-Profil**

- Material: AISI 316L - 1.4404
- O-Ring: EPDM schwarz / I/A
- SVGW Nr.: 0007 - 4278

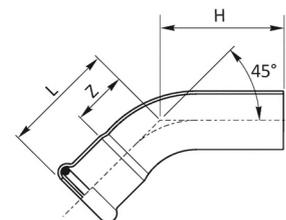

d mm	Winkel °	Z mm	H mm	L mm	Orig. Nr.	Stück	Art.-Nr.	CHF Stück
76.1	45	76.5	149	131.5	181076451	2	448500310	110.00
88.9	45	84	159	144	181088451	2	448500320	131.30
108	45	94	199	169	181108451	2	448500330	179.30
								4485

**Bögen INOXPRES 181/451 Oversize Inox M-Profil**

- Material: AISI 316L - 1.4404
- O-Ring: EPDM schwarz / I/A
- DVGW Nr.: DW-8511AV2084

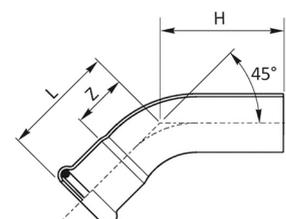

d mm	Winkel °	Z mm	H mm	L mm	Orig. Nr.	Stück	Art.-Nr.	CHF Stück
139.7	45	108	210	203	181139451	1	448700120	546.55
168.3	45	139	261	252	181168451	1	448700130	708.65
								4487

**Bögen INOXPRES 181/600 Inox M-Profil**

- Material: AISI 316L - 1.4404
- O-Ring: EPDM schwarz / I/I
- SVGW Nr.: 0007 - 4278

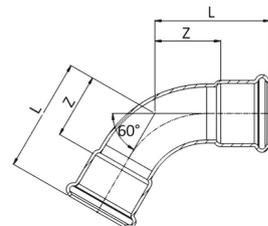

d mm	Winkel °	Z mm	L mm	Orig. Nr.	Stück	Art.-Nr.	CHF Stück
15	60	10.5	30.5	181015600	20	448200660	12.20
18	60	12	32	181018600	20	448200670	13.50
22	60	15	36	181022600	20	448200680	15.70
28	60	19	42	181028600	10	448200690	18.90
35	60	24	50	181035600	10	448200700	24.20
42	60	29	59	181042600	4	448200710	34.95
54	60	37	72.5	181054600	2	448200720	44.85
							4482

**Bögen INOXPRES 181/600 King Size Inox M-Profil**

- Material: AISI 316L - 1.4404
- O-Ring: EPDM schwarz / I/I
- SVGW Nr.: 0007 - 4278



d mm	Winkel °	Z mm	L mm	Orig. Nr.	Stück	Art.-Nr.	CHF Stück
76.1	60	91.5	146.5	181076600	2	448500340	146.40
88.9	60	102	162	181088600	2	448500350	174.45
108	60	115	190	181108600	2	448500360	237.85
							4485

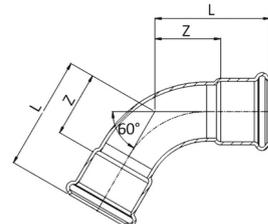

**Bögen INOXPRES 181/601 Inox M-Profil**

- Material: AISI 316L - 1.4404
- O-Ring: EPDM schwarz / I/A
- SVGW Nr.: 0007 - 4278

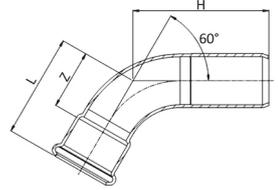

d mm	Winkel °	Z mm	H mm	L mm	Orig. Nr.	Stück	Art.-Nr.	CHF Stück
15	60	10.5	39	30.5	181015601	20	448200730	12.20
18	60	12	41	32	181018601	20	448200740	13.10
22	60	15	46	36	181022601	20	448200750	14.80
28	60	19	51	42	181028601	10	448200760	17.60
35	60	24	64	50	181035601	10	448200770	22.55
42	60	29	80	59	181042601	4	448200780	33.65
54	60	37	92.5	72.5	181054601	2	448200790	43.15
								4482

**Bögen INOXPRES 181/601 King Size Inox M-Profil**

- Material: AISI 316L - 1.4404
- O-Ring: EPDM schwarz / I/A
- SVGW Nr.: 0007 - 4278

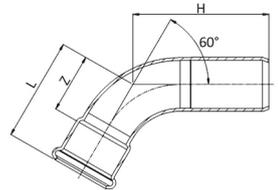

d mm	Winkel °	Z mm	H mm	L mm	Orig. Nr.	Stück	Art.-Nr.	CHF Stück
76.1	60	91.5	164	146.5	181076601	2	448500370	134.30
88.9	60	102	177	162	181088601	2	448500380	160.35
108	60	115	205	190	181108601	2	448500390	219.00
								4485

**Bögen INOXPRES 181/900 Inox M-Profil**

- Material: AISI 316L - 1.4404
- O-Ring: EPDM schwarz / I/I
- SVGW Nr.: 0007 - 4278

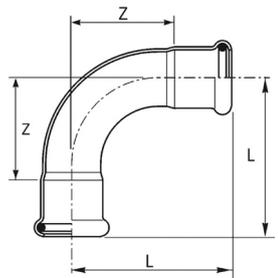

d mm	Winkel °	Z mm	L mm	Orig. Nr.	Stück	Art.-Nr.	CHF Stück
15	90	18	38	181015900C	20	448200840	8.20
18	90	21.5	41.5	181018900C	20	448200850	9.40
22	90	26	47	181022900C	10	448200860	11.35
28	90	33	56	181028900C	10	448200870	15.10
35	90	42	68	181035900	5	448200880	24.50
42	90	50	80	181042900	2	448200890	42.00
54	90	64	100	181054900	2	448200900	58.60
							4482

**Bögen INOXPRES 181/900 King Size Inox M-Profil**

- Material: AISI 316L - 1.4404
- O-Ring: EPDM schwarz / I/I
- SVGW Nr.: 0007 - 4278



d mm	Winkel °	Z mm	L mm	Orig. Nr.	Stück	Art.-Nr.	CHF Stück
76.1	90	105	160	181076900	2	448500400	121.95
88.9	90	122	182	181088900	2	448500410	148.35
108	90	145	220	181108900	2	448500420	202.35
							4485

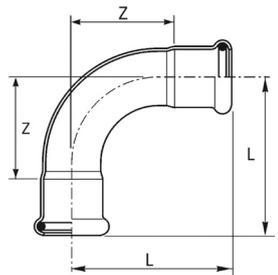

**Bögen INOXPRES 181/900 Oversize Inox M-Profil**

- Material: AISI 316L - 1.4404
- O-Ring: EPDM schwarz / I/I
- DVGW Nr.: DW-8511AV2084

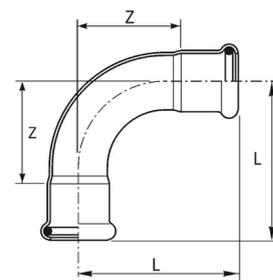

d mm	Winkel °	Z mm	L mm	Orig. Nr.	Stück	Art.-Nr.	CHF Stück
139.7	90	219	314	181139900	1	448700140	555.80
168.3	90	273	386	181168900	1	448700150	717.90
							4487

**Bögen INOXPRES 181/901 Inox M-Profil**

- Material: AISI 316L - 1.4404
- O-Ring: EPDM schwarz / I/A
- SVGW Nr.: 0007 - 4278

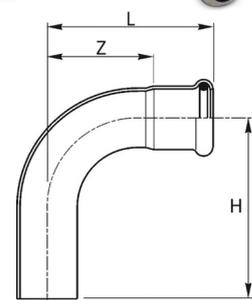

d mm	Winkel °	Z mm	H mm	L mm	Orig. Nr.	Stück	Art.-Nr.	CHF Stück
15	90	18	48	38	181015901C	20	448200910	8.60
18	90	21.5	48.5	41.5	181018901C	20	448200920	9.75
22	90	26	57	47	181022901C	10	448200930	11.75
28	90	33	64	56	181028901C	10	448200940	14.70
35	90	42	82	68	181035901	5	448200950	22.40
42	90	50	101	80	181042901	2	448200960	40.70
54	90	64	120	100	181054901	2	448200970	58.95
							4482	

**Bögen INOXPRES 181/901 King Size Inox M-Profil**

- Material: AISI 316L - 1.4404
- O-Ring: EPDM schwarz / I/A
- SVGW Nr.: 0007 - 4278

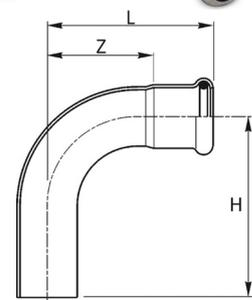

d mm	Winkel °	Z mm	H mm	L mm	Orig. Nr.	Stück	Art.-Nr.	CHF Stück
76.1	90	105	180	160	181076901	2	448500430	125.45
88.9	90	122	197	182	181088901	2	448500440	152.60
108	90	145	236	220	181108901	2	448500450	208.15
							4485	

**Bögen INOXPRES 181/901 Oversize Inox M-Profil**

- Material: AISI 316L - 1.4404
- O-Ring: EPDM schwarz / I/A
- DVGW Nr.: DW-8511AV2084



d mm	Winkel °	Z mm	H mm	L mm	Orig. Nr.	Stück	Art.-Nr.	CHF Stück
139.7	90	219	322	314	181139901	1	448700160	555.80
168.3	90	273	395	386	181168901	1	448700170	717.90
							4487	

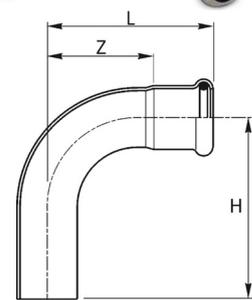



**Passbögen INOXPRES 194/150 Inox M-Profil**

- Material: AISI 316L - 1.4404
- SVGW Nr.: 0007 - 4278



d mm	Winkel °	H min. mm	H1 mm	H2 mm	Orig. Nr.	Stück	Stück	Art.-Nr.	CHF Stück
18	15	40	55	128	194018150	20	120	448200250	13.15
28	15	38	45	136	194028150	10	50	448200270	26.80
35	15	32	62	234	194035150	4	24	448200280	43.25
42	15	50	94	276	194042150	2	10	448200290	63.70
54	15	52	117	337	194054150	2	2	448200300	81.25
									4482

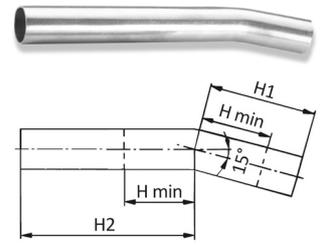

**Passbögen INOXPRES 194/150 King Size Inox M-Profil**

- Material: AISI 316L - 1.4404
- SVGW Nr.: 0007 - 4278



d mm	Winkel °	H min. mm	H1 mm	H2 mm	Orig. Nr.	Stück	Stück	Art.-Nr.	CHF Stück
76.1	15	163	228	228	194076150	1	1	448500160	87.35
88.9	15	160	240	240	194088150	1	1	448500170	94.85
108	15	154	249	249	194108150	1	1	448500180	116.85
									4485

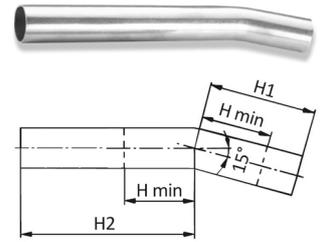

**Passbögen INOXPRES 194/300 Inox M-Profil**

- Material: AISI 316L - 1.4404
- SVGW Nr.: 0007 - 4278



d mm	Winkel °	H min. mm	H1 mm	H2 mm	Orig. Nr.	Stück	Stück	Art.-Nr.	CHF Stück
18	30	39	55	128	194018300	20	120	448200460	13.15
22	30	44	50	124	194022300	10	50	448200470	26.75
28	30	47	55	131	194028300	10	50	448200480	27.40
35	30	50	80	218	194035300	4	24	448200490	44.10
42	30	54	98	274	194042300	2	10	448200500	65.05
54	30	72	137	324	194054300	2	2	448200510	83.35
									4482

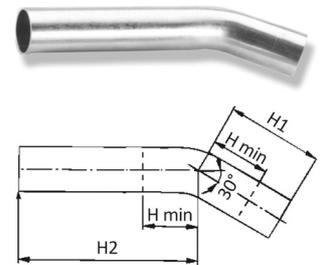

**Passbögen INOXPRES 194/300 King Size Inox M-Profil**

- Material: AISI 316L - 1.4404
- SVGW Nr.: 0007 - 4278



d mm	Winkel °	H min. mm	H1 mm	H2 mm	Orig. Nr.	Stück	Stück	Art.-Nr.	CHF Stück
76.1	30	135	201	201	194076300	1	1	448500250	87.35
88.9	30	161	241	241	194088300	1	1	448500260	94.85
108	30	168	263	263	194108300	1	1	448500270	116.85
									4485

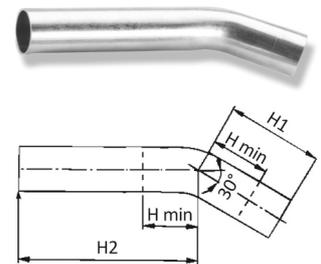

**Passbögen INOXPRES 194/600 Inox M-Profil**

- Material: AISI 316L - 1.4404
- SVGW Nr.: 0007 - 4278



d mm	Winkel °	H min. mm	H1 mm	H2 mm	Orig. Nr.	Stück	Stück	Art.-Nr.	CHF Stück
28	60	64	71	116	194028600	10	50	448200800	28.55
35	60	71	101	226	194035600	4	24	448200810	45.95
42	60	80	124	251	194042600	2	10	448200820	67.80
54	60	97	162	308	194054600	2	2	448200830	87.40
									4482

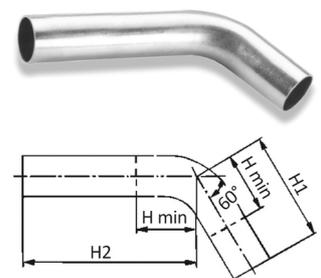

**Passbögen INOXPRES 194/900 Inox M-Profil**

- Material: AISI 316L - 1.4404
- SVGW Nr.: 0007 - 4278

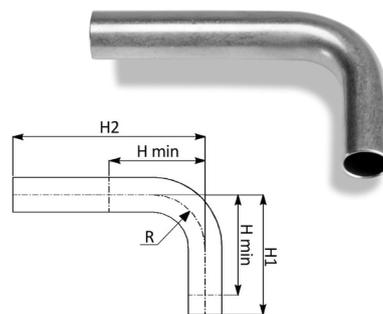

d mm	Winkel °	H min. mm	H1 mm	R mm	H2 mm	Orig. Nr.	Stück	Art.-Nr.	CHF Stück
15	90	48	70	35	120	194015900	20	448200980	14.30
18	90	53	70	38	120	194018900	20	448200990	14.85
22	90	61	70	40	120	194022900	10	448201000	16.00
28	90	80	97	45	125	194028900	10	448201010	17.10
35	90	90	120	42	200	194035900	4	448201020	34.75
42	90	115	160	50	250	194042900	2	448201030	43.00
54	90	140	300	65	305	194054900	2	448201040	54.05
									4482

**Sprungbögen INOXPRES 179 Inox M/V-Profil**

- Material: AISI 316L - 1.4404
- SVGW Nr.: 1911 - 6889

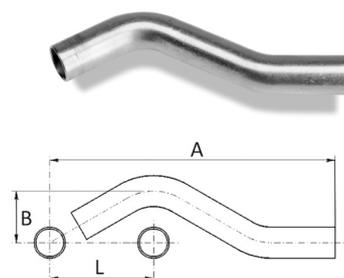

d mm	L mm	A mm	B mm	Orig. Nr.	Stück	Art.-Nr.	CHF Stück
15	57	158	30	179015000	10	448204870	14.05
18	60	166	31	179018000	10	448204880	14.60
22	65	179	33	179022000	10	448204890	16.35
28	73	206	36	179028000	10	448204900	19.85
							4482

**Bögen INOXPRES 186 Inox M-Profil**

- Mit Aussengewinde
- Material: AISI 316L - 1.4404
- Gewindenorm: EN 10226-1 (ex ISO 7/1)
- O-Ring: EPDM schwarz
- SVGW Nr.: 0007 - 4278

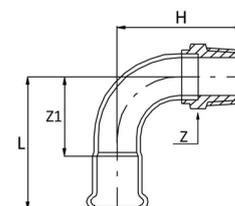

d mm	Winkel °	AG (R) Zoll	Z mm	H mm	Z1 mm	L mm	Orig. Nr.	Stück	Art.-Nr.	CHF Stück
15	90	1/2	24	54	30	50	186102015C	20	448201240	26.10
18	90	1/2	24	59	34	54	186102018C	20	448201250	27.35
22	90	3/4	30	69	39	60	186304022C	10	448201260	31.95
28	90	1	36	80	50	73	186100028C	10	448201270	37.90
35	90	1	41	85	42	68	186100035	5	448201280	44.80
35	90	1 1/4	46	89	42	68	186114035	5	448201290	48.00
42	90	1 1/4	50	107	50	80	186114042	2	448201300	56.00
42	90	1 1/2	55	107	50	80	186112042	2	448201310	56.85
54	90	2	65	141.5	65	100	186200054	2	448201320	67.20
									4482	

**Bögen INOXPRES 186/R Inox M-Profil**

- Mit Anschlussverschraubungen
- Material: AISI 316L - 1.4404
- Gewindenorm: ISO 228/1 (ex DIN 259)
- O-Ring / Dichtung: EPDM schwarz
- SVGW Nr.: 0007 - 4278



d mm	Winkel °	IG (G) Zoll	Z mm	H mm	Z1 mm	Z2 mm	L mm	Orig. Nr.	Stück	Art.-Nr.	CHF Stück
42	90	1 3/4	58	77.5	50	67.5	80	186042134R	1	448201330	95.20
54	90	2 3/8	75	96	64.5	83.5	100	186054238R	1	448201340	111.30
									4482		

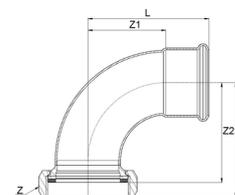

**Deckenwinkel INOXPRES 185/000 Inox M-Profil**

- Material: AISI 316L - 1.4404
- Gewindenorm: EN 10226-1 (ex ISO 7/1)
- O-Ring: EPDM schwarz / I/I
- SVGW Nr.: 0007 - 4278

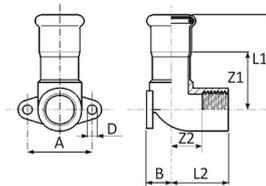

d mm	IG (Rp) Zoll	Winkel °	Z1 mm	A mm	L1 mm	Z2 mm	L2 mm	B mm	D mm	Orig. Nr.	Stück	Art.-Nr.	CHF Stück
15	1/2	90	30	34	50	17	30	13	5	185102015	10	448201350	20.45
18	1/2	90	31	34	51	17	30	13	5	185102018	10	448201360	21.25
22	3/4	90	34	40	55	19	34	17	6	185304022	10	448201370	30.55
													4482

**Deckenwinkel INOXPRES 185/001 Inox M-Profil**

- Material: AISI 316L - 1.4404 / W - I/I
- Gewindenorm: EN 10226-1 (ex ISO 7/1)
- O-Ring: EPDM schwarz
- SVGW Nr.: 0007 - 4278

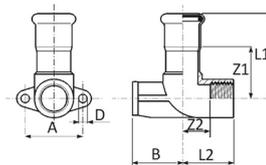

d mm	IG (Rp) Zoll	Winkel °	Z1 mm	A mm	L1 mm	Z2 mm	L2 mm	B mm	D mm	Orig. Nr.	Stück	Art.-Nr.	CHF Stück
15	1/2	90	30	34	50	17	30	35	5	185102115	10	448201380	22.20
18	1/2	90	31	34	51	17	30	35	5	185102118	10	448201390	23.30
22	3/4	90	34	40	55	19	34	31	6	185304122	10	448201400	31.60
													4482

**Deckenwinkel INOXPRES 185/002 Inox M-Profil**

- Material: AISI 316L - 1.4404 ( I/A
- Gewindenorm: EN 10226-1 (ex ISO 7/1)
- O-Ring: EPDM schwarz
- SVGW Nr.: 0007 - 4278

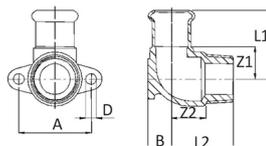

d mm	AG (R) Zoll	Winkel °	Z1 mm	A mm	L1 mm	Z2 mm	L2 mm	B mm	D mm	Orig. Nr.	Stück	Art.-Nr.	CHF Stück
18	3/4	90	18	40	38	19	34	13	6	185304218	10	448201410	27.00
													4482

**Deckenwinkel INOXPRES 185/000M Inox M-Profil**

- Material: AISI 316L - 1.4404 / A/I
- Gewindenorm: EN 10226-1 (ex ISO 7/1)
- SVGW Nr.: 0007 - 4278



d mm	IG (Rp) Zoll	Winkel °	Z1 mm	A mm	L1 mm	Z2 mm	L2 mm	B mm	D mm	Orig. Nr.	Stück	Art.-Nr.	CHF Stück
15	1/2	90	21	34	52	16.5	30	13	5	185102015M	10	448201420	20.80
18	1/2	90	21	34	52	17	30.5	12.5	5	185102018M	10	448201430	21.60
22	3/4	90	24	40	55	19	34	17	6	185304022M	10	448201440	31.10
													4482

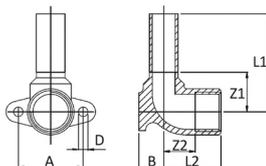

**Deckenwinkel INOXPRES 185/001M Inox M-Profil**

- Material: AISI 316L - 1.4404 / A/I
- Gewindenorm: EN 10226-1 (ex ISO 7/1)
- SVGW Nr.: 0007 - 4278



d mm	IG (Rp) Zoll	Winkel °	Z1 mm	A mm	L1 mm	Z2 mm	L2 mm	B mm	D mm	Orig. Nr.	Stück	Art.-Nr.	CHF Stück
15	1/2	90	21	34	52	16.5	30	35	5	185102115M	10	448201450	22.20
18	1/2	90	21	34	52	16.5	30	35	5	185102118M	10	448201460	23.30
22	3/4	90	24	40	55	19.0	34	31	6	185304122M	10	448201470	31.60
													4482

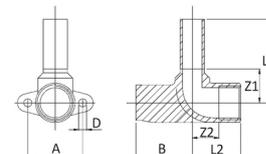

**Doppelwandscheiben INOXPRES 185/003 Inox M-Profil**

- Material: AISI 316L - 1.4404
- Gewindenorm: EN 10226-1 (ex ISO 7/1)
- O-Ring: EPDM schwarz
- SVGW Nr.: 0007 - 4278



d mm	IG (Rp) Zoll	Z1 mm	A mm	L1 mm	Z2 mm	L2 mm	B mm	D mm	Orig. Nr.	Stück	Art.-Nr.	CHF Stück
15	1/2	23	40	43	18.5	32	13	6	185102315	10	448201480	44.65
18	1/2	21	40	41	18.5	32	13	6	185102318	10	448201490	46.15
22	1/2	23	40	44	21.5	35	15	6	185102322	5	448201500	51.15
												4482

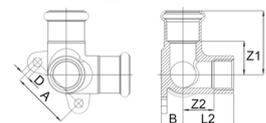

**T-Stücke INOXPRES 182 Inox M-Profil**

- Material: AISI 316L - 1.4404
- O-Ring: EPDM schwarz
- SVGW Nr.: 0007 - 4278



d mm	Z1 mm	L1 mm	Z2 mm	L2 mm	Orig. Nr.	Stück	Art.-Nr.	CHF Stück
15	14	34	19	39	182015000	20	448201510	15.00
18	16	37	21	41	182018000	20	448201520	17.30
22	18	39	24	45	182022000	10	448201530	18.15
28	21	44	27	50	182028000	10	448201540	21.85
35	25	51	31	57	182035000	4	448201550	27.25
42	28	59	35	65	182042000	4	448201560	38.50
54	34	70	42	77	182054000	2	448201570	45.95
								4482

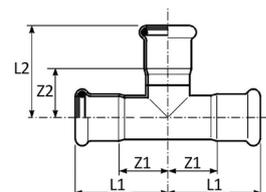

**T-Stücke INOXPRES 182 King Size Inox M-Profil**

- Material: AISI 316L - 1.4404
- O-Ring: EPDM schwarz
- SVGW Nr.: 0007 - 4278



d mm	Z1 mm	L1 mm	Z2 mm	L2 mm	Orig. Nr.	Stück	Art.-Nr.	CHF Stück
76.1	53	108	63	118	182076000	2	448500460	228.90
88.9	72	132	71	131	182088000	2	448500470	250.65
108	74	155	84	159	182108000	2	448500480	308.95
								4485

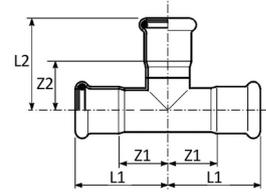



### T-Stücke INOXPRES 182 Oversize Inox M-Profil

- Material: AISI 316L - 1.4404
- O-Ring: EPDM schwarz
- DVGW Nr.: DW-8511AV2084



d mm	Z1 mm	L1 mm	Z2 mm	L2 mm	Orig. Nr.	Stück	Art.-Nr.	CHF Stück
139.7	102	197	127	222	182139000	1	448700180	819.30
168.3	144	257	155	268	182168000	1	448700190	1029.95
								4487

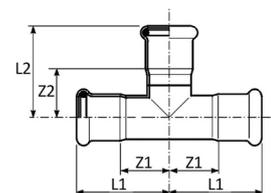

### T-Stücke INOXPRES 192 Inox M-Profil

- Mit reduziertem Abgang
- Material: AISI 316L - 1.4404
- O-Ring: EPDM schwarz
- SVGW Nr.: 0007 - 4278



d mm	Z1 mm	L1 mm	Z2 mm	L2 mm	Orig. Nr.	Stück	Art.-Nr.	CHF Stück
18 x 15 x 18	15.5	36.5	21	41	192018015	20	448201580	14.55
22 x 15 x 22	18	39	23	43	192022015	10	448201590	15.25
22 x 18 x 22	18	39	23	44	192022018	10	448201600	16.00
28 x 15 x 28	21	44	26	46	192028015	10	448201610	18.15
28 x 18 x 28	21	44	26	46	192028018	10	448201620	18.95
28 x 22 x 28	21	44	26	47	192028022	10	448201630	20.25
35 x 15 x 35	25	51	29	49	192035015	5	448201640	23.60
35 x 18 x 35	25	51	30	50	192035018	5	448201650	23.90
35 x 22 x 35	25	51	30	51	192035022	5	448201660	24.70
35 x 28 x 35	25	51	31	54	192035028	5	448201670	25.65
42 x 18 x 42	29	59	34	54	192042018	4	448201680	34.20
42 x 22 x 42	29	59	33	54	192042022	4	448201690	35.35
42 x 28 x 42	29	59	34	57	192042028	4	448201700	36.15
42 x 35 x 42	29	59	35	61	192042035	4	448201710	37.00
54 x 18 x 54	34	70	41	61	192054018	2	448201720	38.25
54 x 22 x 54	34	70	41	62	192054022	2	448201730	39.00
54 x 28 x 54	34	70	42	65	192054028	2	448201740	40.65
54 x 35 x 54	34	70	42	68	192054035	2	448201750	41.45
54 x 42 x 54	34	70	42	72	192054042	2	448201760	44.40
								4482

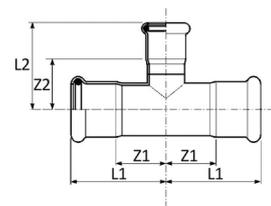

**T-Stücke INOXPRES 192 King Size Inox M-Profil**

- Mit reduziertem Abgang
- Material: AISI 316L - 1.4404
- O-Ring: EPDM schwarz
- SVGW Nr.: 0007 - 4278

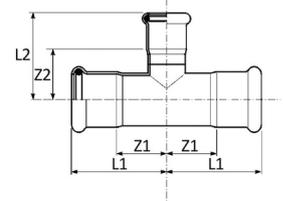

d mm	Z1 mm	L1 mm	Z2 mm	L2 mm	Orig. Nr.	Stück	Art.-Nr.	CHF Stück
76.1 x 22 x 76.1	53	108	53	74	192076022	2	448500490	179.00
76.1 x 28 x 76.1	53	108	54	77	192076028	2	448500500	193.55
76.1 x 35 x 76.1	53	108	54	80	192076035	2	448500510	208.10
76.1 x 42 x 76.1	53	108	54	84	192076042	2	448500520	224.50
76.1 x 54 x 76.1	53	108	55	90	192076054	2	448500530	239.05
88.9 x 22 x 88.9	72	132	60	81	192088022	2	448500540	189.90
88.9 x 28 x 88.9	72	132	61	84	192088028	2	448500550	200.80
88.9 x 35 x 88.9	72	132	62	88	192088035	2	448500560	218.85
88.9 x 42 x 88.9	72	132	61	91	192088042	2	448500570	231.10
88.9 x 54 x 88.9	72	132	62	97	192088054	2	448500580	244.70
88.9 x 76.1 x 88.9	72	132	70	125	192088076	2	448500590	261.00
108 x 22 x 108	74	155	70	91	192108022	2	448500600	204.05
108 x 28 x 108	74	155	71	94	192108028	2	448500610	213.75
108 x 35 x 108	74	155	71	97	192108035	2	448500620	236.75
108 x 42 x 108	74	155	71	101	192108042	2	448500630	244.70
108 x 54 x 108	74	155	72	107	192108054	2	448500640	266.35
108 x 76.1 x 108	74	155	80	135	192108076	2	448500650	279.40
108 x 88.9 x 108	74	155	81	141	192108088	2	448500660	322.75
								4485

**T-Stücke INOXPRES 192 Oversize Inox M-Profil**

- Mit reduziertem Abgang
- Material: AISI 316L - 1.4404
- O-Ring: EPDM schwarz
- DVGW Nr.: DW-8511AV2084

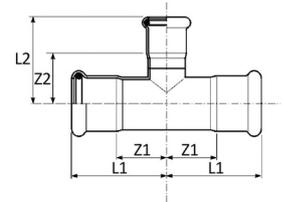

d mm	Z1 mm	L1 mm	Z2 mm	L2 mm	Orig. Nr.	Stück	Art.-Nr.	CHF Stück
139.7x35x139.7	102	197	91	117	192139035	1	448700200	684.75
139.7x76.1x139.7	102	197	100	155	192139076	1	448700210	716.30
139.7x88.9x139.7	102	197	104	164	192139088	1	448700220	735.00
139.7x108x139.7	102	197	105	180	192139108	1	448700230	749.05
168.3x35x168.3	144	257	104	130	192168035	1	448700240	837.45
168.3x76.1x168.3	144	257	114	169	192168076	1	448700250	866.10
168.3x88.9x168.3	144	257	118	178	192168088	1	448700260	889.50
168.3x108x168.3	144	257	119	194	192168108	1	448700270	912.95
168.3x139.7x168.3	144	257	126	221	192168139	1	448700280	983.15
								4487

**T-Stücke INOXPRES 189/MF Inox M-Profil**

- Mit Innengewinde und Einsteckende
- Material: AISI 316L - 1.4404
- Gewindenorm: EN 10226-1 (ex ISO 7/1)
- O-Ring: EPDM schwarz
- SVGW Nr.: 0007 - 4278



d mm	IG (Rp) Zoll	Z1 mm	L1 mm	Z2 mm	L2 mm	Z3 mm	L3 mm	Orig. Nr.	Stück	Art.-Nr.	CHF Stück
22	1/2	18	50	18	39	12	26	189102022MF	5	448202000	14.25
28	3/4	21	58	21	44	14	30	189304028MF	5	448202010	18.00
											4482

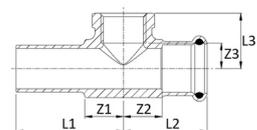



### T-Stücke INOXPRES 189/M Inox M-Profil

- Mit Abgang und Aussengewinde
- Material: AISI 316L - 1.4404
- Gewindenorm: EN 10226-1 (ex ISO 7/1)
- O-Ring: EPDM schwarz
- SVGW Nr.: 0007 - 4278



d mm	AG (Rp) Zoll	Z1 mm	L1 mm	Z2 mm	L2 mm	Orig. Nr.	Stück	Art.-Nr.	CHF Stück
15	1/2	14.5	34.5	20	34	189102015M	20	448201990	24.20 4482

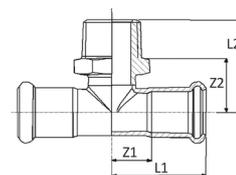

### T-Stücke INOXPRES 189 Inox M-Profil

- Mit Abgang und Innengewinde
- Material: AISI 316L - 1.4404
- Gewindenorm: EN 10226-1 (ex ISO 7/1)
- O-Ring: EPDM schwarz
- SVGW Nr.: 0007 - 4278



d mm	IG (Rp) Zoll	Z1 mm	L1 mm	Z2 mm	L2 mm	Orig. Nr.	Stück	Art.-Nr.	CHF Stück
15	1/2	16.5	36.5	8.5	22.5	189102015	20	448201820	16.60
18	1/2	16	36	10	24	189102018	20	448201830	17.05
18	3/4	18.5	38.5	11	26	189304018	20	448201840	20.75
22	1/2	18	39	12	26	189102022	10	448201850	18.20
22	3/4	20.5	41.5	14	30	189304022	10	448201860	20.80
28	1	21	44	16	34	189100028	5	448201890	37.70
28	1/2	21	44	15	29	189102028	10	448201870	20.05
28	3/4	21	44	14	30	189304028	10	448201880	23.85
35	1/2	25	51	36	51	189102035	5	448201900	24.05
35	3/4	25	51	37	54	189304035	5	448201910	29.15
35	1	25	51	37	56	189100035	5	448201920	46.55
42	1/2	29	59	39	54	189102042	4	448201930	29.15
42	3/4	29	59	41	57	189304042	4	448201940	31.90
42	1	29	59	41	60	189100042	4	448201950	51.00
54	1/2	34	70	46	61	189102054	2	448201960	35.20
54	3/4	34	70	48	64	189304054	2	448201970	38.15
54	2	37	70	55	81	189200054	2	448201980	76.70 4482

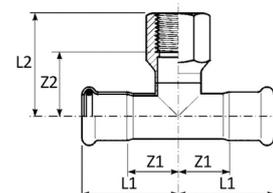

### T-Stücke INOXPRES 189 King Size Inox M-Profil

- Mit Abgang und Innengewinde
- Material: AISI 316L - 1.4404
- Gewindenorm: EN 10226-1 (ex ISO 7/1)
- O-Ring: EPDM schwarz
- SVGW Nr.: 0007 - 4278



d mm	IG (Rp) Zoll	Z1 mm	L1 mm	Z2 mm	L2 mm	Orig. Nr.	Stück	Art.-Nr.	CHF Stück
76.1	1	53	108	60	79	189100076	2	448500680	207.75
76.1	3/4	53	108	60	77	189304076	2	448500670	200.35
76.1	2	53	108	67	93	189200076	2	448500690	219.10
88.9	2	72	132	74	100	189200088	2	448500710	227.50
88.9	3/4	72	132	67	84	189304088	2	448500700	216.15
108	3/4	74	155	77	94	189304108	2	448500720	264.90
108	2	74	155	84	110	189200108	2	448500730	280.80 4485

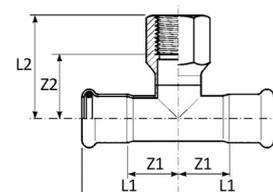

**T-Stücke INOXPRES 189 Oversize Inox M-Profil**

- Mit Abgang und Innengewinde
- Material: AISI 316L - 1.4404
- Gewindenorm: EN 10226-1 (ex ISO 7/1)
- O-Ring: EPDM schwarz
- DVGW Nr.: DW-8511AV2084

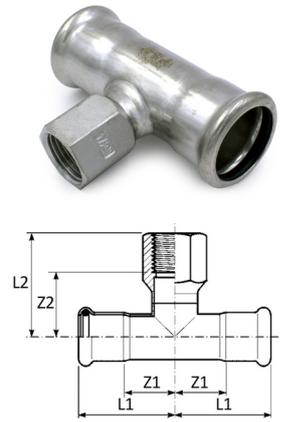

d mm	IG (Rp) Zoll	Z1 mm	L1 mm	Z2 mm	L2 mm	Orig. Nr.	Stück	Art.-Nr.	CHF Stück
139.7	1	102	197	88	107	189100139	1	448700290	684.75
139.7	2	102	197	104	130	189200139	1	448700300	706.10
168.3	1	144	257	101	120	189100168	1	448700310	837.45
168.3	2	144	257	117	143	189200168	1	448700320	853.90
									4487

**T-Stücke INOXPRES 188 Inox M-Profil**

- Mit reduziertem Abgang A/I/A
- Material: AISI 316L - 1.4404
- O-Ring: EPDM schwarz
- SVGW Nr.: 0007 - 4278

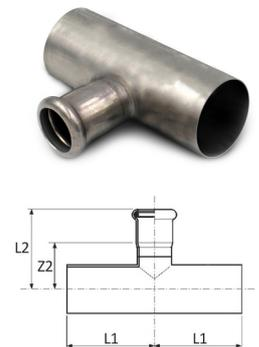

d mm	L1 mm	Z2 mm	L2 mm	Orig. Nr.	Stück	Art.-Nr.	CHF Stück
28 x 22 x 28	52.5	26	47	188028022	10	448201770	33.25
35 x 22 x 35	60.0	29.5	50.5	188035022	5	448201780	37.50
35 x 28 x 35	60.0	30.5	53.5	188035028	5	448201790	41.00
42 x 28 x 42	69.0	34	57.0	188042028	4	448201800	45.50
54 x 28 x 54	73.5	41.5	64.5	188054028	2	448201810	51.65
							4482

**Muffen INOXPRES 183/000 Inox M-Profil**

- Material: AISI 316L - 1.4404
- O-Ring: EPDM schwarz
- SVGW Nr.: 0007 - 4278

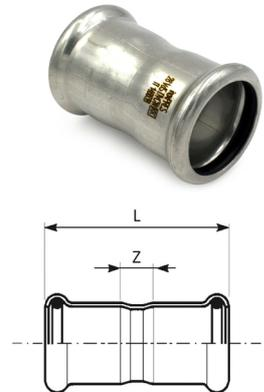

d mm	Z mm	L mm	Orig. Nr.	Stück	Art.-Nr.	CHF Stück
15	9	49	183015000	20	448202020	5.75
18	10	50	183018000	20	448202030	6.60
22	11	53	183022000	20	448202040	7.55
28	10	56	183028000	10	448202050	8.65
35	10	63	183035000	10	448202060	10.95
42	12	72	183042000	4	448202070	14.85
54	13	83	183054000	2	448202080	18.00
						4482

**Muffen INOXPRES 183/000 King Size Inox M-Profil**

- Material: AISI 316L - 1.4404
- O-Ring: EPDM schwarz
- SVGW Nr.: 0007 - 4278



d mm	Z mm	L mm	Orig. Nr.	Stück	Art.-Nr.	CHF Stück
76.1	32	142	183076000	4	448500740	77.15
88.9	46	166	183088000	4	448500750	88.15
108	41	203	183108000	2	448500760	112.20
						4485

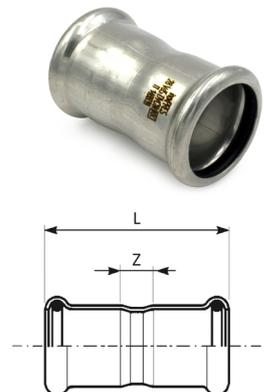



### Muffen INOXPRES 183/000 Oversize Inox M-Profil

- Material: AISI 316L - 1.4404
- O-Ring: EPDM schwarz
- DVGW Nr.: DW-8511AV2084



d mm	Z mm	L mm	Orig. Nr.	Stück	Art.-Nr.	CHF Stück
139.7	60	250	183139000	1	448700330	277.90
168.3	74	300	183168000	1	448700340	347.40
						4487

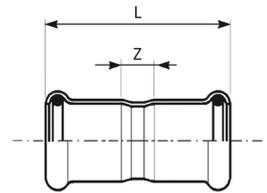

### Schiebemuffen INOXPRES 183/001 Inox M-Profil

- Material: AISI 316L - 1.4404
- O-Ring: EPDM schwarz
- SVGW Nr.: 0007 - 4278



d mm	es mm	L mm	Orig. Nr.	Stück	Art.-Nr.	CHF Stück
15	25	69	183015001	20	448202090	11.45
18	25	73	183018001	20	448202100	11.95
22	25	79	183022001	20	448202110	13.85
28	30	88.5	183028001	10	448202120	16.25
35	30	102.5	183035001	10	448202130	20.85
42	40	117.5	183042001	4	448202140	24.90
54	40	139	183054001	2	448202150	34.30
						4482

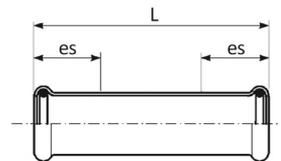

### Schiebemuffen INOXPRES 183/001 King Size Inox M-Profil

- Material: AISI 316L - 1.4404
- O-Ring: EPDM schwarz
- SVGW Nr.: 0007 - 4278



d mm	es mm	L mm	Orig. Nr.	Stück	Art.-Nr.	CHF Stück
76.1	60	230	183076001	2	448500770	210.60
88.9	70	260	183088001	2	448500780	239.30
108	80	310	183108001	2	448500790	296.05
						4485

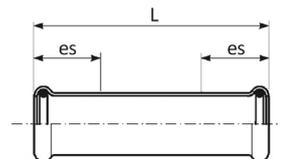

**Reduzierstücke INOXPRES 191 Inox M-Profil**

- Material: AISI 316L - 1.4404
- O-Ring: EPDM schwarz
- SVGW Nr.: 0007 - 4278

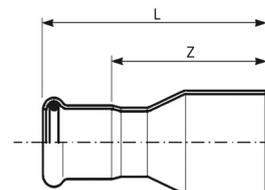

d mm	Z mm	L mm	Orig. Nr.	Stück	Art.-Nr.	CHF Stück
18 x 15	37	57	191018015	20	448202160	6.70
22 x 15	44	64	191022015	20	448202170	7.35
22 x 18	40	60	191022018	20	448202180	7.55
28 x 15	56.5	76.5	191028015	20	448202190	9.45
28 x 18	48	68	191028018	20	448202200	8.85
28 x 22	44	65	191028022	20	448202210	8.80
35 x 15	67	87	191035015	10	448202220	32.45
35 x 18	61	81	191035018	10	448202230	32.80
35 x 22	49	70	191035022	10	448202240	27.65
35 x 28	48	71	191035028	10	448202250	21.40
42 x 15	71	91	191042015	4	448202260	33.55
42 x 18	72	92	191042018	4	448202270	33.65
42 x 22	76	97	191042022	4	448202280	34.85
42 x 28	70	93	191042028	4	448202290	35.65
42 x 35	55	81	191042035	4	448202300	23.20
54 x 15	83	103	191054015	4	448202310	37.25
54 x 18	83	103	191054018	4	448202320	37.25
54 x 22	83	104	191054022	4	448202330	39.25
54 x 28	85.5	108.5	191054028	4	448202340	40.85
54 x 35	82	108	191054035	4	448202350	50.85
54 x 42	67.5	97.5	191054042	4	448202360	24.70
						4482

**Reduzierstücke INOXPRES 191 King Size Inox M-Profil**

- Material: AISI 316L - 1.4404
- O-Ring: EPDM schwarz
- SVGW Nr.: 0007 - 4278

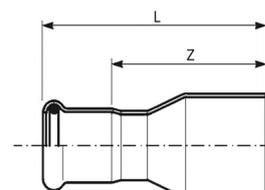

d mm	Z mm	L mm	Orig. Nr.	Stück	Art.-Nr.	CHF Stück
76.1 x 42	119	149	191076042	4	448500800	65.20
76.1 x 54	124	159	191076054	4	448500810	66.65
88.9 x 54	144	179	191088054	4	448500820	72.50
88.9 x 76.1	131	186	191088076	4	448500830	98.50
108 x 54	150	185	191108054	2	448500840	78.15
108 x 76.1	154	209	191108076	2	448500850	101.45
108 x 88.9	150	210	191108088	2	448500860	113.00
						4485

**Reduzierstücke INOXPRES 191 Oversize Inox M-Profil**

- Material: AISI 316L - 1.4404
- O-Ring: EPDM schwarz
- DVGW Nr.: DW-8511AV2084



d mm	Z mm	L mm	Orig. Nr.	Stück	Art.-Nr.	CHF Stück
139.7 x 76.1	301.5	356.5	191139076	1	448700350	509.35
139.7 x 88.9	320	380	191139088	1	448700360	486.30
139.7 x 108	270	345	191139108	1	448700370	463.15
168.3 x 76.1	315	369	191168076	1	448700380	587.05
168.3 x 88.9	320	380	191168088	1	448700390	555.80
168.3 x 108	320	395	191168108	1	448700400	532.65
168.3 x 139.7	327	422	191168139	1	448700410	509.50
						4487

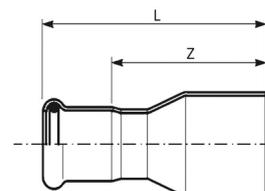



### Übergangsstücke INOXPRES 187 Inox M-Profil

- Mit Aussengewinde
- Material: AISI 316L - 1.4404
- Gewinde: ISO 7/1 - ANSI B 1.20.1
- O-Ring: EPDM schwarz
- SVGW Nr.: 0007 - 4278



d mm	AG (R) Zoll	Z mm	Y mm	L mm	Orig. Nr.	Stück	Art.-Nr.	CHF Stück
15	1/2	24	21	41	187102015	20	448202520	14.55
15	3/8	24	18	38	187308015	20	448202510	11.90
15	3/4	30	23	43	187304015	20	448202530	14.75
18	1/2	27	21	41	187102018	20	448202540	15.85
18	3/4	30	24	44	187304018	20	448202550	16.55
22	3/4	32	23	44	187304022	10	448202570	17.85
22	1/2	32	21	42	187102022	10	448202560	17.20
22	1	36	25	46	187100022	10	448202580	21.20
28	3/4	38	24	47	187304028	10	448202600	24.20
28	1	38	25	48	187100028	10	448202610	27.75
28	1 1/4	46	30	53	187114028	5	448202620	32.05
28	1/2	38	23	46	187102028	10	448202590	24.20
35	1	45	25	52	187100035	5	448202630	29.20
35	1 1/2	50	28	55	187112035	4	448202650	40.05
35	1 1/4	46	28	55	187114035	5	448202640	33.95
42	1 1/2	54	28	59	187112042	4	448202670	49.35
42	1 1/4	55	28	59	187114042	4	448202660	45.50
54	1 1/2	65	29	65	187112054	4	448202680	57.25
54	2	65	35	71	187200054	4	448202690	61.35
								4482

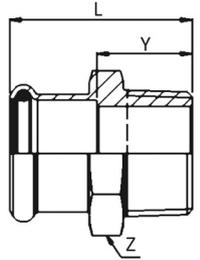

### Übergangsstücke INOXPRES 187 King Size Inox M-Profil

- Mit Aussengewinde
- Material: AISI 316L - 1.4404
- Gewinde: ISO 7/1 - ANSI B 1.20.1
- O-Ring: EPDM schwarz
- SVGW Nr.: 0007 - 4278



d mm	AG (R) Zoll	Z mm	Y mm	L mm	Orig. Nr.	Stück	Art.-Nr.	CHF Stück
76.1	2 1/2	83	43	98	187212076	2	448500930	251.35
88.9	3	98	51	111	187300088	2	448500940	375.50
108	4	118	57	132	187400108	2	448500950	432.25
								4485

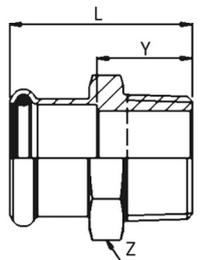

### Übergangsstücke INOXPRES 187 NPT Inox M-Profil

- Mit Aussengewinde NPT
- Material: AISI 316L - 1.4404
- Gewinde: NPT - ANSI B 1.20.1
- O-Ring: EPDM schwarz
- SVGW Nr.: 0007 - 4278



4482

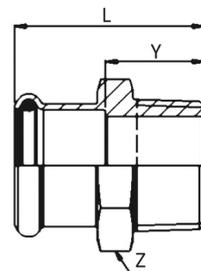

### Übergangsstücke INOXPRES 190 Inox M-Profil

- Mit Innengewinde
- Material: AISI 316L - 1.4404
- Gewinde: ISO 7/1 - ANSI B 1.20.1
- O-Ring: EPDM schwarz
- SVGW Nr.: 0007 - 4278



d mm	IG (Rp) Zoll	Z mm	Y mm	L mm	Orig. Nr.	Stück	Art.-Nr.	CHF Stück
15	1/2	27	2	38	190102015	20	448202770	15.65
15	3/4	32	2	39	190304015	20	448202780	16.35
18	1/2	27	2	38	190102018	20	448202790	16.55
18	3/4	32	2	39	190304018	10	448202800	17.30
22	1/2	32	2	39	190102022	20	448202810	17.55
22	3/4	32	2	40	190304022	10	448202820	20.55
22	1	41	2	43	190100022	10	448202830	24.30
28	1/2	38	2	41	190102028	10	448202840	23.45
28	3/4	38	2	42	190304028	10	448202850	23.45
28	1	41	2	45	190100028	10	448202860	32.20
28	1 1/4	46	2	48	190114028	10	448202870	35.70
35	1	46	2	49	190100035	5	448202880	30.95
35	1 1/4	46	2	52	190114035	5	448202890	35.10
35	1 1/2	55	2	52	190112035	4	448202900	40.15
42	1 1/4	55	2	56	190114042	4	448202910	39.70
42	1 1/2	55	2	56	190112042	4	448202920	54.75
54	1 1/2	65	1	60	190112054	4	448202930	59.60
54	2	65	2	65	190200054	4	448202940	81.50

4482

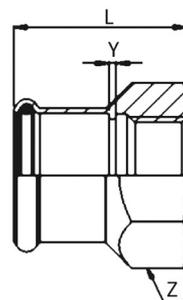



### Übergangsstücke INOXPRES 190 NPT Inox M-Profil

- Mit Innengewinde NPT
- Material: AISI 316L - 1.4404
- Gewinde: NPT - ANSI B 1.20.1
- O-Ring: EPDM schwarz
- SVGW Nr.: 0007 - 4278

4482

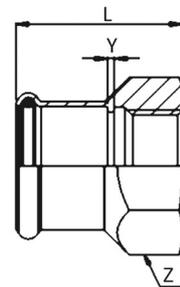

### Übergänge INOXPRES 269/M Inox M-Profil

- Aussengewinde mit Einschubende
- Material: AISI 316L - 1.4404
- Gewindenorm: EN 10226-1 (ex ISO 7/1)
- SVGW Nr.: 1911 - 6889



d mm	AG (R) Zoll	Z mm	Y mm	L mm	Orig. Nr.	Stück	Art.-Nr.	CHF Stück
15	1/2	31	22	52	269102115	20	448203020	14.85
18	1/2	31	22	52	269102118	20	448203030	16.25
18	3/4	31	27	55	269304118	20	448203040	16.05
22	1/2	32	27	55	269102122	10	448203050	17.45
22	3/4	32	27	56	269304122	10	448203060	18.30
28	3/4	37	30	61	269304128	10	448203070	22.95
28	1	37	38	64	269100128	10	448203080	25.05
35	1 1/4	41	45	72	269114135	4	448203090	26.95
42	1 1/2	55	55	91	269112142	4	448203100	31.30
54	2	83	65	127	269200154	4	448203110	52.35
								4482

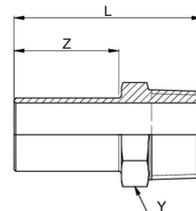

### Übergänge INOXPRES 269/F Inox M-Profil

- Innengewinde mit Einschubende
- Material: AISI 316L - 1.4404
- Gewindenorm: EN 10226-1 (ex ISO 7/1)
- SVGW Nr.: 1911 - 6889



d mm	IG (Rp) Zoll	Z mm	Y mm	L mm	Orig. Nr.	Stück	Art.-Nr.	CHF Stück
15	1/2	31	24	52	269102015	20	448203120	16.20
18	1/2	31	24	52	269102018	20	448203130	17.05
18	3/4	31	30	51	269304018	20	448203140	17.70
22	1/2	32	24	52	269102022	10	448203150	18.00
22	3/4	32	30	52	269304022	10	448203160	21.25
28	3/4	37	30	57	269304028	10	448203170	22.95
28	1	35	36	57	269100028	10	448203180	34.40
35	1 1/4	45	46	70	269114035	5	448203190	48.25
42	1 1/2	78	55	118	269112042	4	448203200	53.20
54	2	83	70	135	269200054	2	448203210	72.95
								4482

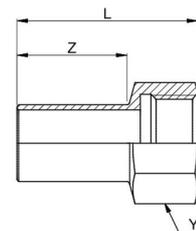

**Durchgangsverschraubungen INOXPRES 184/000 Inox M-Profil**

- Mit Pressenden konisch
- Material: AISI 316L - 1.4404
- O-Ring: EPDM schwarz
- SVGW Nr.: 0007 - 4278

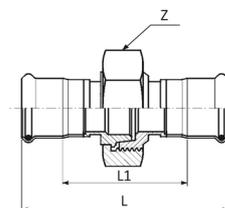

d mm	Z mm	L1 mm	L mm	Orig. Nr.	Stück	Art.-Nr.	CHF Stück
15	34	56	96	184015000	10	448203390	31.70
18	39	57	97	184018000	10	448203400	37.50
22	39	57	99	184022000	10	448203410	42.05
28	58	70	116	184028000	5	448203420	54.60
35	67	71	123	184035000	4	448203430	68.90
42	77	78	138	184042000	2	448203440	85.40
54	90	84	154	184054000	2	448203450	161.40
							4482

**Durchgangsverschraubungen INOXPRES 184/001 Inox M-Profil**

- Mit Pressenden flachdichtend
- Material: AISI 316L - 1.4404
- O-Ring / Dichtung: EPDM schwarz
- SVGW Nr.: 0007 - 4278

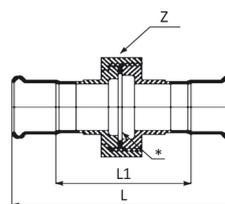

d mm	Z mm	L1 mm	L mm	Orig. Nr.	Stück	Art.-Nr.	CHF Stück
15	34	56	96	184015001	10	448203460	31.70
18	39	57	97	184018001	10	448203470	37.50
22	39	58	100	184022001	10	448203480	42.05
28	58	71	117	184028001	5	448203490	54.60
35	67	75	127	184035001	4	448203500	68.90
42	77	80	140	184042001	2	448203510	85.40
54	90	82	152	184054001	2	448203520	161.40
							4482

**Durchgangsverschraubungen INOXPRES 184/002 Inox M-Profil**

- Mit Aussengewinde, Anschlussmuffe Messing
- Material: AISI 316L - 1.4404
- Gewindenorm: EN 10226-1 (ex ISO 7/1)
- O-Ring / Dichtung: EPDM schwarz
- SVGW Nr.: 0007 - 4278



d mm	AG (R) Zoll	Z mm	L mm	Orig. Nr.	Stück	Art.-Nr.	CHF Stück
15	1/2	56	77	184015002	2	448203530	28.25
18	1/2	56	77	184018002	2	448203540	32.20
22	1/2	54	79	184022122	2	448203550	33.15
22	3/4	59	81	184022002	2	448203560	33.15
28	3/4	64	87	184028342	2	448203570	56.55
28	1	67	90	184028002	2	448203580	56.55
35	1 1/4	74	101	184035002	2	448203590	72.20
42	1 1/2	74	105	184042002	2	448203600	82.90
54	2	83	118	184054002	2	448203610	142.35
							4482

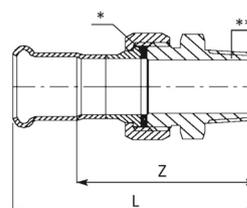



### Durchgangsverschraubungen INOXPRES 184/003 Inox M-Profil

- Mit Innengewinde, Anschlussmuffe Messing
- Material: AISI 316L - 1.4404
- Gewindenorm: EN 10226-1 (ex ISO 7/1)
- O-Ring / Dichtung: EPDM schwarz
- SVGW Nr.: 0007 - 4278



d mm	IG (Rp) Zoll	Z mm	L mm	Orig. Nr.	Stück	Art.-Nr.	CHF Stück
15	1/2	50	71	184015003	2	448203620	28.25
18	1/2	51	72	184018003	2	448203630	34.10
22	1/2	54	75	184022123	2	448203640	37.05
22	3/4	54	76	184022003	2	448203650	37.05
28	3/4	60	83	184028343	2	448203660	48.80
28	1	60	83	184028003	2	448203670	48.80
35	1 1/4	66	93	184035003	2	448203680	60.45
42	1 1/2	66	97	184042003	2	448203690	75.15
54	2	81	116	184054003	2	448203700	143.35
							4482

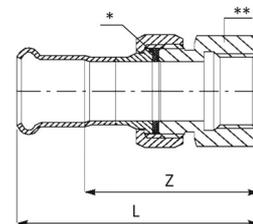

### Durchgangsverschraubungen INOXPRES 184/002 Inox M-Profil

- Mit Aussengewinde
- Material: AISI 316L - 1.4404
- Gewindenorm: EN 10226-1 (ex ISO 7/1)
- O-Ring / Dichtung: EPDM schwarz
- SVGW Nr.: 0007 - 4278



d mm	AG (R) Zoll	Z mm	L mm	Orig. Nr.	Stück	Art.-Nr.	CHF Stück
15	1/2	56	77	184015002I	2	448203710	35.35
15	3/4	57	77	184015012I	2	448203720	36.55
18	1/2	56	77	184018002I	2	448203730	40.25
18	3/4	57	77	184018012I	2	448203740	41.25
22	1/2	58	79	184022012I	2	448203750	41.45
22	3/4	59	81	184022002I	2	448203760	42.50
22	1	60	81	184022022I	2	448203770	68.75
28	1	67	90	184028002I	2	448203780	70.70
35	1 1/4	74	101	184035002I	2	448203790	90.20
42	1 1/2	71.5	102	184042002I	2	448203800	95.30
54	2	77	111	184054002I	2	448203810	163.75
							4482

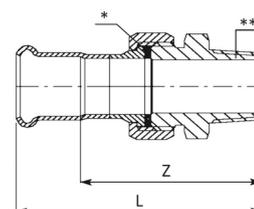

### Durchgangsverschraubungen INOXPRES 184/003 Inox M-Profil

- Mit Innengewinde, Anschlussmuffe Inox
- Material: AISI 316L - 1.4404
- Gewindenorm: EN 10226-1 (ex ISO 7/1)
- O-Ring / Dichtung: EPDM schwarz
- SVGW Nr.: 0007 - 4278



d mm	Rp Zoll	Z mm	L mm	Orig. Nr.	Stück	Art.-Nr.	CHF Stück
15	1/2	50.0	71	184015003I	2	448203820	35.35
15	3/4	54.0	74	184015013I	2	448203830	39.25
18	1/2	51.0	72	184018003I	2	448203840	42.60
18	3/4	55.0	75	184018013I	2	448203850	44.00
22	3/4	54.0	76	184022003I	2	448203860	47.00
22	1	58.0	79	184022013I	2	448203870	49.30
28	1	60.0	83	184028003I	2	448203880	60.95
35	1 1/4	66.0	93	184035003I	2	448203890	75.60
42	1 1/2	62.5	93	184042003I	2	448203900	86.40
54	2	77.0	111	184054003I	2	448203910	164.85
							4482

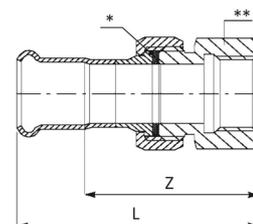

**Übergangswinkel INOXPRES 197 Inox M-Profil**

- Mit Aussengewinde
- Material: AISI 316L - 1.4404
- Gewindenorm: EN 10226-1 (ex ISO 7/1)
- O-Ring: EPDM schwarz
- SVGW Nr.: 0007 - 4278

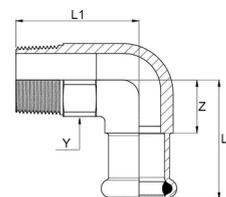

d mm	AG (R) Zoll	Winkel °	Z mm	Y mm	L1 mm	L2 mm	Orig. Nr.	Stück	Art.-Nr.	CHF Stück
15	1/2	90	16	22	37	36	197102015	10	448201050	17.40
18	1/2	90	16	22	37	36	197102018	10	448201060	19.90
22	1/2	90	16	22	41	37	197102022	10	448201070	22.75
22	3/4	90	22	28	44	43	197304022	10	448201080	25.50
28	3/4	90	22	28	44	45	197304028	5	448201090	34.00
28	1	90	27	36	56	50	197100028	5	448201100	34.35
35	1 1/4	90	50.5	46	63	76.5	197114035	5	448201110	43.60
42	1 1/2	90	50	50	67.5	80	197112042	2	448201120	73.40
54	2	90	56	65	78.5	91.5	197200054	2	448201130	93.25
										4482

**Übergangswinkel INOXPRES 198 Inox M-Profil**

- Mit Innengewinde
- Material: AISI 316L - 1.4404
- Gewindenorm: EN 10226-1 (ex ISO 7/1)
- O-Ring: EPDM schwarz
- SVGW Nr.: 0007 - 4278

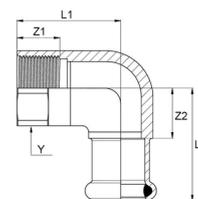

d mm	IG (Rp) Zoll	Winkel °	Y mm	Z1 mm	L1 mm	Z2 mm	L2 mm	Orig. Nr.	Stück	Art.-Nr.	CHF Stück
15	1/2	90	24	15	33	16	36	198102015	10	448201140	18.35
15	3/4	90	30	19	38	22	42	198304015	10	448201150	24.60
18	1/2	90	24	15	33	16	36	198102018	10	448201160	21.10
22	1/2	90	24	15	33	16	37	198102022	10	448201170	23.50
22	3/4	90	30	19	38	22	43	198304022	10	448201180	25.70
28	1/2	90	24	15	33	16	39	198102028	5	448201190	25.05
28	1	90	38	21	48	27	50	198100028	5	448201200	33.60
35	1 1/4	90	46	21	48	50.5	76.5	198114035	5	448201210	55.35
42	1 1/2	90	50	21	51	50	80	198112042	2	448201220	60.75
54	2	90	65	26	66	56	92	198200054	2	448201230	71.00
										4482	

**Anschlussverschraubungen INOXPRES 183/002 Inox M-Profil**

- Material: AISI 316L - 1.4404
- Gewindenorm: ISO 228/1 (ex DIN 259)
- O-Ring / Dichtung: EPDM schwarz
- SVGW Nr.: 0007 - 4278



d mm	IG (G) Zoll	Z mm	Y mm	L mm	Orig. Nr.	Stück	Art.-Nr.	CHF Stück
15	1/2	27	23	48.5	183015012	10	448203220	16.65
15	3/4	30	23	50.0	183015002	10	448203230	16.80
18	1/2	27	23.5	49.0	183018012	10	448203240	18.40
18	3/4	30	23.5	50.0	183018002	10	448203250	18.45
22	3/4	30	19.5	50.0	183022012	10	448203260	21.60
22	1	36	23	52.0	183022002	10	448203270	21.60
28	1	36	19.5	52.0	183028012	10	448203280	26.85
28	1 1/4	46	25	57.0	183028002	10	448203290	26.85
28	1 1/2	52	22.5	59.0	183028022	10	448203300	26.85
35	1 1/4	46	20.5	57.5	183035012	4	448203310	30.45
35	1 1/2	52	26	63.0	183035002	4	448203320	30.45
42	1 1/2	52	21	63.5	183042022	2	448203330	41.10
42	1 3/4	58	27	68.0	183042012	2	448203340	41.10
42	2	64	27	68.0	183042002	2	448203350	54.05
54	2	64	23	72.0	183054022	2	448203360	49.50
54	2 3/8	75	30	77.0	183054012	2	448203370	55.30
54	2 1/2	81	30	77.0	183054002	2	448203380	77.30
								4482

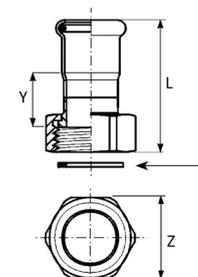



### Übergangsflansche INOXPRES 193/002 Inox M-Profil

- Material: AISI 316L - 1.4404
- O-Ring: EPDM schwarz
- SVGW Nr.: 0007 - 4278
- PN 6



De mm	DN flg	Z mm	H mm	B mm	D mm	Lochanzahl Stück	K mm	D2 mm	Orig. Nr.	Stück	Art.-Nr.	CHF Stück
15	15	33	53	12	80	4	55	11	193015002	2	448203920	56.25
18	15	33.5	53.5	12	80	4	55	11	193018002	2	448203930	57.85
22	20	35.5	56.5	14	90	4	65	11	193022002	2	448203940	68.40
28	25	36.5	59.5	14	100	4	75	11	193028002	2	448203950	83.65
35	32	37	63	14	120	4	90	14	193035002	2	448203960	118.05
42	40	37	67	14	130	4	100	14	193042002	2	448203970	138.55
54	50	38	74	14	140	4	110	14	193054002	2	448203980	170.80
												4482

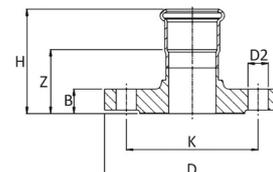

### Übergangsflansche INOXPRES 193/002 King Size Inox M-Profil

- Material: AISI 316L - 1.4404
- O-Ring: EPDM schwarz
- SVGW Nr.: 0007 - 4278
- PN 6



De mm	DN flg	Z mm	H mm	B mm	D mm	Lochanzahl Stück	K mm	D2 mm	Orig. Nr.	Stück	Art.-Nr.	CHF Stück
76.1	65	45.5	101	14	160	4	130	14	193076002	2	448500960	250.90
88.9	80	52	112	16	190	4	150	18	193088002	2	448500970	299.35
108	100	53	128	16	210	4	170	18	193108002	2	448500980	356.35
												4485

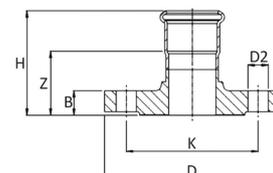

### Übergangsflansche INOXPRES 193/000 Inox M-Profil

- Material: AISI 316L - 1.4404
- O-Ring: EPDM schwarz
- SVGW Nr.: 0007 - 4278
- PN 16



De mm	DN flg	Z mm	H mm	B mm	D mm	Lochanzahl Stück	K mm	D2 mm	Orig. Nr.	Stück	Art.-Nr.	CHF Stück
15	15	35.0	55.0	14	95	4	65	14	193015000	2	448204000	63.80
18	15	35.5	55.5	14	95	4	65	14	193018000	2	448204010	65.55
22	20	37.5	58.5	16	105	4	75	14	193022000	2	448204020	77.55
28	25	38.5	61.5	16	115	4	85	14	193028000	2	448204030	94.85
35	32	39.5	65.5	16	140	4	100	18	193035000	2	448204040	133.90
42	40	39.0	69.0	16	150	4	110	18	193042000	2	448204050	157.05
54	50	42.0	78.0	18	165	4	125	18	193054000	2	448204060	193.65
												4482

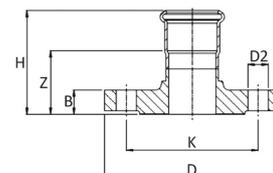

### Übergangsflansche INOXPRES 193/000 King Size Inox M-Profil

- Material: AISI 316L - 1.4404
- O-Ring: EPDM schwarz
- SVGW Nr.: 0007 - 4278
- PN 16



De mm	DN flg	Z mm	H mm	B mm	D mm	Lochanzahl Stück	K mm	D2 mm	Orig. Nr.	Stück	Art.-Nr.	CHF Stück
76.1	65	50	105	18	185	4	145	18	193076000	2	448501020	272.45
88.9	80	56	116	20	200	8	160	18	193088000	2	448501030	325.10
108	100	57	132	20	220	8	180	18	193108000	2	448501040	387.00
												4485

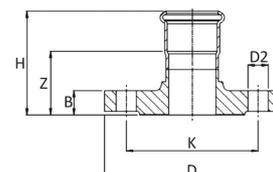

**Übergangsflansche INOXPRES 193/000 Oversize Inox M-Profil**

- Material: AISI 316L - 1.4404
- O-Ring: EPDM schwarz
- PN 16
- DVGW Nr.: DW-8511AV2084

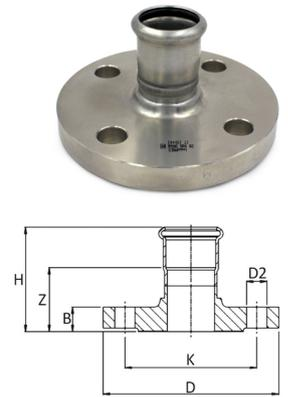

De mm	DN flg	Z mm	H mm	B mm	D mm	Lochanzahl Stück	K mm	D2 mm	Orig. Nr.	Stück	Art.-Nr.	CHF Stück
139.7	125	85	180	22	250	8	210	18	193139000	1	448700480	706.10
168.3	150	91.5	212	22	285	8	240	22	193168000	1	448700490	802.50
												4487

**Verschlusskappen INOXPRES 183/003 Inox M-Profil**

- Material: AISI 316L - 1.4404
- O-Ring: EPDM schwarz
- SVGW Nr.: 0007 - 4278

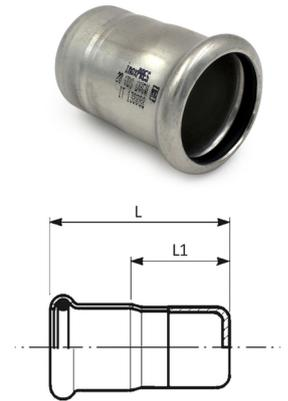

d mm	L1 mm	L mm	Orig. Nr.	Stück	Art.-Nr.	CHF Stück
15	24	44	183015003	20	448202440	8.15
18	24	44	183018003	20	448202450	8.50
22	24	45	183022003	10	448202460	9.85
28	25	48	183028003	10	448202470	13.60
35	26	52	183035003	5	448202480	15.50
42	26	56	183042003	4	448202490	23.80
54	27	62	183054003	4	448202500	27.75
						4482

**Verschlusskappen INOXPRES 183/003 King Size Inox M-Profil**

- Material: AISI 316L - 1.4404
- O-Ring: EPDM schwarz
- SVGW Nr.: 0007 - 4278

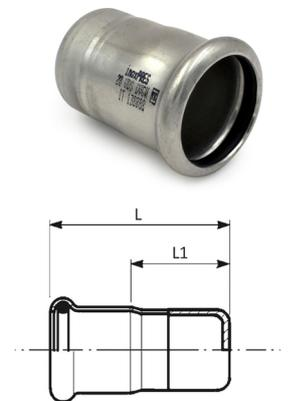

d mm	L1 mm	L mm	Orig. Nr.	Stück	Art.-Nr.	CHF Stück
76.1	38	93	183076003	2	448500900	47.00
88.9	39	99	183088003	2	448500910	58.20
108	42	117	183108003	2	448500920	71.55
						4485

**Verschlusskappen INOXPRES 183/003 Oversize Inox M-Profil**

- Material: AISI 316L - 1.4404
- O-Ring: EPDM schwarz
- DVGW Nr.: DW-8511AV2084



d mm	L1 mm	L mm	Orig. Nr.	Stück	Art.-Nr.	CHF Stück
139.7	67	162	183139003	1	448700440	222.30
168.3	86	199	183168003	1	448700450	254.75
						4487

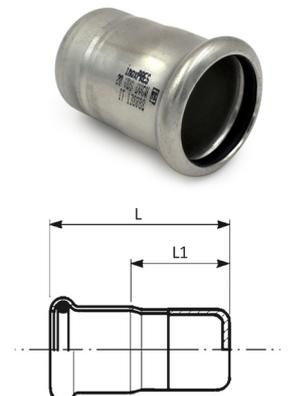

**Schweissmuffen INOXPRES 187/R Inox M-Profil**

- Material: AISI 316L - 1.4404
- SVGW Nr.: 0007 - 4278

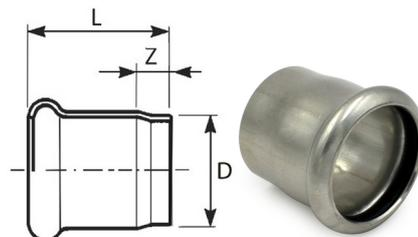

De mm	Z mm	D mm	L mm	Orig. Nr.	Stück	Art.-Nr.	CHF Stück
15	9	17.2	29	187015000R	20	448202370	5.65
18	9.5	20	29.5	187018000R	20	448202380	6.75
22	9.5	24	30.5	187022000R	20	448202390	7.60
28	10.5	30	33.5	187028000R	20	448202400	7.80
35	11.5	37	37.5	187035000R	10	448202410	9.55
42	11	44	41	187042000R	10	448202420	9.85
54	12	56	48	187054000R	10	448202430	10.30
							4482

**Schweissmuffen INOXPRES 187/R King Size Inox M-Profil**

- Material: AISI 316L - 1.4404
- SVGW Nr.: 0007 - 4278

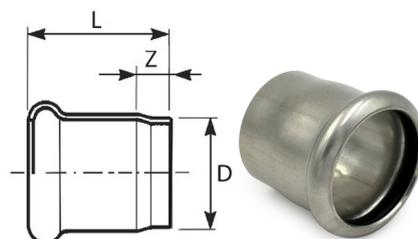

De mm	Z mm	D mm	L mm	Orig. Nr.	Stück	Art.-Nr.	CHF Stück
76.1	19.5	76.1	74.5	187076000R	4	448500870	43.20
88.9	24	88.9	84	187088000R	2	448500880	55.55
108	25	108	100	187108000R	1	448500890	74.95
							4485

**Schweissmuffen INOXPRES 187/R Oversize Inox M-Profil**

- Material: AISI 316L - 1.4404
- DVGW Nr.: DW-8511AV2084

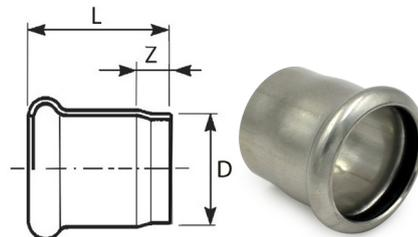

De mm	Z mm	D mm	L mm	Orig. Nr.	Stück	Art.-Nr.	CHF Stück
139.7	32	139.7	127	187139000R	1	448700420	138.95
168.3	46	168.3	159	187168000R	1	448700430	173.70
							4487

**Sprungbögen INOXPRES 178 Inox M-Profil**

- Für Druckluft
- Material: AISI 316L - 1.4404
- SVGW Nr.: 0007 - 4278



d mm	R mm	Z1 mm	L1 mm	Z2 mm	L2 mm	Orig. Nr.	Stück	Art.-Nr.	CHF Stück
15	35	96	30	114	30	178015316	1	448204830	35.05
18	39	108	50	112	35	178018316	1	448204840	37.55
22	41	110	50	110	35	178022316	1	448204850	44.35
28	51	139	60	113	40	178028316	1	448204860	62.10
									4482

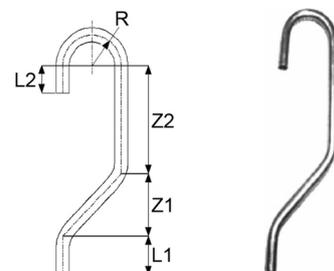

**Übergangsflansche INOXPRES 193/006 Inox M-Profil**

- Material: AISI 316L - 1.4404
- O-Ring: EPDM schwarz
- SVGW Nr.: 0007 - 4278
- ANSI 150 lb

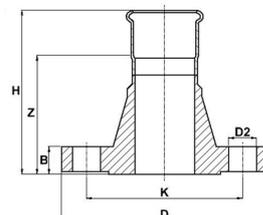

De mm	DN flg	Z mm	H mm	B mm	D mm	Lochanzahl Stück	K mm	D2 mm	Stück	Art.-Nr.	Orig. Nr.	CHF Stück
15	15	59.7	79.7	14.1	89	4	60.3	15.8	2	448204070	193015006	65.60
18	15	57.1	77.1	11.2	89	4	60.3	15.8	2	448204080	193018006	67.40
22	20	61.9	82.9	12.8	98.5	4	69.8	15.8	2	448204090	193022006	79.80
28	25	66.1	89.1	14.3	108	4	79.3	15.8	2	448204100	193028006	97.55
35	32	68.4	94.4	15.9	117.5	4	88.9	15.8	2	448204110	193035006	137.65
42	40	72.9	102.9	17.5	127.1	4	98.4	15.8	2	448204120	193042006	161.50
54	50	75.5	111.1	19.1	152.5	4	120.6	19.0	2	448204130	193054006	199.10
												4482

**Übergangsflansche INOXPRES 193/006 King Size Inox M-Profil**

- Material: AISI 316L - 1.4404
- O-Ring: EPDM schwarz
- SVGW Nr.: 0007 - 4278
- ANSI 150 lb

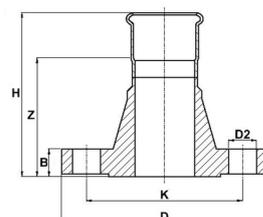

De mm	DN flg	Z mm	H mm	B mm	D mm	Lochanzahl Stück	K mm	D2 mm	Stück	Art.-Nr.	Orig. Nr.	CHF Stück
76.1	65	67.5	122.5	22.3	177.9	4	139.7	19	2	448501050	193076006	354.20
88.9	80	90.9	150.9	23.8	190.6	4	152.4	19	2	448501060	193088006	422.65
108	100	97.2	172.2	23.8	228.7	8	190.5	19	2	448501070	193108006	503.05
												4485

**Übergangsflansche INOXPRES 193/001 Inox M-Profil**

- Material: 1 - AISI 316L - 1.4404 / 2 - AISI 304 - 1.4301
- O-Ring: EPDM schwarz
- PN 10
- SVGW Nr.: 0007 - 4278

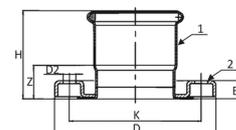

De mm	DN flg	Z mm	H mm	B mm	D mm	Lochanzahl Stück	K mm	D2 mm	Orig. Nr.	Stück	Art.-Nr.	CHF Stück
54	50	24	60	21	165	4	125	18	193054001	2	448203990	122.95
												4482

**Übergangsflansche INOXPRES 193/001 Oversize Inox M-Profil**

- Material: 1 - AISI 316L - 1.4404 / 2 - AISI 304 - 1.4301
- O-Ring: EPDM schwarz
- PN 10
- DVGW Nr.: DW-8511AV2084



De mm	DN flg	Z mm	H mm	B mm	D mm	Lochanzahl Stück	K mm	D2 mm	Orig. Nr.	Stück	Art.-Nr.	CHF Stück
139.7	125	48	143	25.5	250	8	210	18	193139001	1	448700460	589.05
168.3	150	63	176	30	285	8	240	22	193168001	1	448700470	673.20
												4487

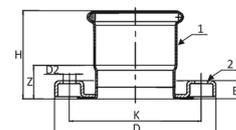



**Übergangsflansche INOXPRES 193/001 King Size Inox M-Profil**

- Material: 1 - AISI 316L - 1.4404 / 2 - AISI 304 - 1.4301
- O-Ring: EPDM schwarz
- PN 10
- SVGW Nr.: 0007 - 4278



De mm	DN flg	Z mm	H mm	B mm	D mm	Lochanzahl Stück	K mm	D2 mm	Orig. Nr.	Stück	Art.-Nr.	CHF Stück
76.1	65	31.5	86.5	23	185	4	145	18	193076001	2	448500990	139.40
88.9	80	36	96	23.5	200	8	160	18	193088001	2	448501000	163.65
108	100	41	116	24	220	8	180	18	193108001	2	448501010	180.60
												4485

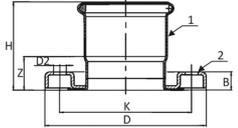

**Flansche lose INOXPRES 193/004 Inox M-Profil**

- Material: AISI 316L - 1.4404
- PN 6
- SVGW Nr.: 0007 - 4278



De mm	H mm	D mm	L mm	D1 mm	D2 mm	Orig. Nr.	Stück	Art.-Nr.	CHF Stück
22	6	50	135	27	22	193022004	2	448204140	42.30
28	6	60	135	32	28	193028004	2	448204150	49.35
35	6	70	135	40	35	193035004	2	448204160	59.75
42	6	80	135	46	42	193042004	2	448204170	68.00
54	8	90	135	54	54	193054004	2	448204180	81.35
									4482

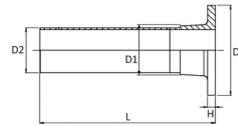

**Flansche lose INOXPRES 193/004 King Size Inox M-Profil**

- Material: AISI 316L - 1.4404
- PN 6
- SVGW Nr.: 0007 - 4278



De mm	H mm	D mm	L mm	D1 mm	D2 mm	Orig. Nr.	Stück	Art.-Nr.	CHF Stück
76.1	8	110	135	78	76.1	193076004	2	448501080	97.60
88.9	10	128	135	91	88.9	193088004	2	448501090	118.90
108	10	148	135	110	108	193108004	2	448501100	150.85
									4485

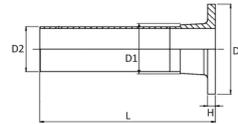

**Flansche lose INOXPRES 193/003 Inox M-Profil**

- Material: AISI 316L - 1.4404
- PN 16
- SVGW Nr.: 0007 - 4278



De mm	H mm	D mm	L mm	D1 mm	D2 mm	Orig. Nr.	Stück	Art.-Nr.	CHF Stück
22	6	58	135	27	22	193022003	2	448204190	43.45
28	6	68	135	32	28	193028003	2	448204200	53.55
35	6	78	135	40	35	193035003	2	448204210	61.75
42	6	88	135	46	42	193042003	2	448204220	70.30
54	8	102	135	54	54	193054003	2	448204230	88.25
									4482

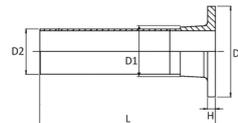

**Flansche lose INOXPRES 193/003 King Size Inox M-Profil**

- Material: AISI 316L - 1.4404
- PN 16
- SVGW Nr.: 0007 - 4278



De mm	H mm	D mm	L mm	D1 mm	D2 mm	Orig. Nr.	Stück	Art.-Nr.	CHF Stück
76.1	8	122	135	78	76.1	193076003	2	448501110	105.10
88.9	10	138	135	91	88.9	193088003	2	448501120	125.50
108	10	158	135	110	108	193108003	2	448501130	158.70
									4485

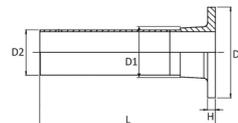

**Anbohrschellen INOXPRES 171/P King Size**

- Mit Pressenden
- Material: AISI 316L - 1.4404
- O-Ring: EPDM schwarz
- Dichtung: EPDM



D1 mm	D2 mm	D3 mm	A mm	B mm	C mm	L mm	M mm	Orig. Nr.	Stück	Art.-Nr.	CHF Stück
76.1	35	40	79	44	100	35	10 x 35	171076035	1	448501170	43.95
88.9	42	47	99	50	115	40	10 x 35	171088042	1	448501180	76.45
108	54	59	116	60	135	45	10 x 35	171108054	1	448501190	103.70
											4485

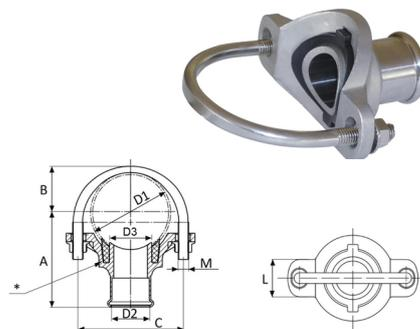

**Wanddurchführungen INOXPRES 179/001**

- Material: AISI 316L - 1.4404
- SVGW Nr.: 0007 - 4278



De mm	Z mm	L1 mm	D mm	L mm	D1 mm	Orig. Nr.	Stück	Art.-Nr.	CHF Stück	
15	165	120	25	450	15	179015001	1	448204240	31.30	
18	165	120	30	450	18	179018001	1	448204250	31.65	
22	165	120	33	450	22	179022001	1	448204260	31.90	
28	165	120	37	450	28	179028001	1	448204270	32.45	
35	165	120	43.5	450	35	179035001	1	448204280	36.10	
42	165	120	53	450	42	179042001	1	448204290	42.85	
54	165	120	59	450	54	179054001	1	448204300	69.05	
										4482

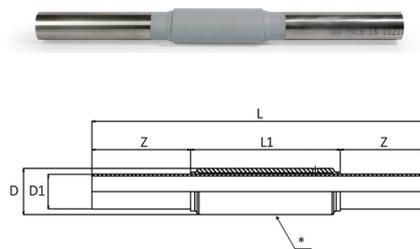

**Wanddurchführungen INOXPRES 179/001 King Size**

- Material: AISI 316L - 1.4404
- SVGW Nr.: 0007 - 4278



De mm	Z mm	L1 mm	D mm	L mm	D1 mm	Orig. Nr.	Stück	Art.-Nr.	CHF Stück	
76.1	165	120	88.5	450	76.1	179076001	1	448501140	70.85	
88.9	165	120	107	450	88.9	179088001	1	448501150	83.70	
108	165	120	131.5	450	108	179108001	1	448501160	111.80	
										4485

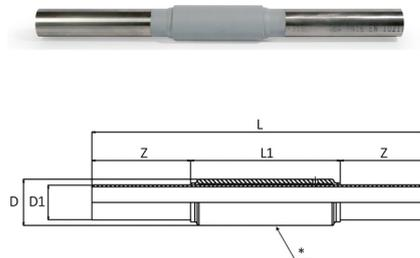

**UP-Ventile INOXPRES 195/000**

- Mit Pressenden
- Material: AISI 316L - 1.4404
- O-Ring: EPDM schwarz
- SVGW Nr.: 0007 - 4278



d mm	Z mm	A mm	B mm	C mm	Orig. Nr.	Stück	Art.-Nr.	CHF Stück	
15	42	101	74	70	195015000	1	448204310	118.30	
									4482

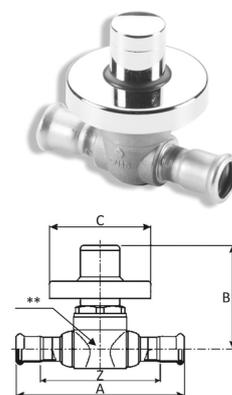



**Kugelhahnen INOXPRES 195/005 Inox M-Profil**

- Mit vollem Durchgang
- Material: A-C: AISI 316L - 1.4404 B: PTFE
- O-Ring: EPDM schwarz
- SVGW Nr.: 0007 - 4278



d mm	Z mm	H mm	L1 mm	L mm	Orig. Nr.	Stück	Art.-Nr.	CHF Stück
15	20	50	97.5	85	195015005	1	448204320	67.65
18	20	59	123	88	195018005	1	448204330	80.75
22	21	62.5	123	100	195022005	1	448204340	101.20
28	23	69.5	145	107	195028005	1	448204350	136.00
								4482

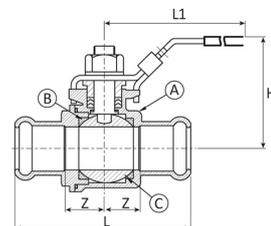

**Kugelhahnen INOXPRES 195/003 Inox M-Profil**

- 3-Teilig, mit vollem Durchgang
- Material: A-B-D: AISI 316L - 1.4404 C: PTFE
- Norm: Flansch für Stellantrieb ISO 5211
- O-Ring: EPDM schwarz
- SVGW Nr.: 0007 - 4278



De mm	F mm	DN Zoll	DN Zoll	Z mm	L1 mm	L2 mm	L mm	C1 mm	C2 mm	D1 mm	D2 mm	Orig. Nr.	Stück	Art.-Nr.	CHF Stück
15	9	10	3/8	44.0	72	151	128	36	42	6	6	195015003	1	448204360	104.20
18	9	15	1/2	47	72	151	134	36	42	6	6	195018003	1	448204370	112.45
22	9	20	3/4	54.5	80	151	151	36	50	6	7	195022003	1	448204380	120.40
28	11	25	1	60.5	90	179	167	42	50	6	7	195028003	1	448204390	170.25
35	11	32	1 1/4	66	95	179	184	42	70	6	9	195035003	1	448204400	242.10
42	14	40	1 1/2	73.5	104	198	207	50	70	7	9	195042003	1	448204410	308.10
54	14	50	2	87.5	110	198	245	50	70	7	9	195054003	1	448204420	381.75
															4482

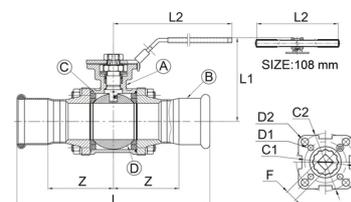

**Kugelhahnen INOXPRES 195/003 King Size Inox M-Profil**

- 3-Teilig, mit vollem Durchgang
- Material: A-B-D: AISI 316L - 1.4404 C: PTFE
- Norm: Flansch für Stellantrieb ISO 5211
- O-Ring: EPDM schwarz
- SVGW Nr.: 0007 - 4278



De mm	F mm	DN Zoll	DN Zoll	Z mm	L1 mm	L2 mm	L mm	C1 mm	C2 mm	D1 mm	D2 mm	Orig. Nr.	Stück	Art.-Nr.	CHF Stück
76.1	17	65	2 1/2	112	150	270	334	70	102	9	11	195076003	1	448501200	716.85
88.9	17	80	3	132	159	270	384	70	102	9	11	195088003	1	448501210	1001.80
108	22	100	4	160	210	405	470	--	102	--	11	195108003	1	448501220	1735.40
															4485

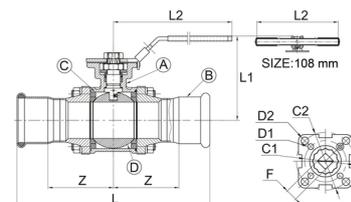

**Rückschlagventile INOXPRES 195/004 Inox M-Profil**

- Material: AISI 316L - 1.4404
- O-Ring: EPDM schwarz
- SVGW Nr.: 0007 - 4278

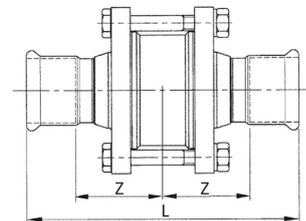

d mm	DN	Z mm	L mm	Orig. Nr.	Stück	Art.-Nr.	CHF Stück
15	15	37	114	195015004	1	448204430	141.00
18	15	37	114	195018004	1	448204440	159.65
22	20	39.5	121	195022004	1	448204450	170.65
28	25	46	138	195028004	1	448204460	214.10
35	32	53	158	195035004	1	448204470	243.45
42	40	60	180	195042004	1	448204480	300.00
54	50	64.5	200	195054004	1	448204490	413.00
							4482

**Rückschlagventile INOXPRES 195/004 King Size Inox M-Profil**

- Material: AISI 316L - 1.4404
- O-Ring: EPDM schwarz
- SVGW Nr.: 0007 - 4278

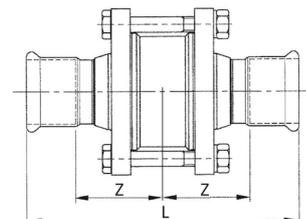

d mm	DN	Z mm	L mm	Orig. Nr.	Stück	Art.-Nr.	CHF Stück
76.1	65	80.5	271	195076004	1	448501230	743.75
88.9	80	91	302	195088004	1	448501240	1133.45
							4485

**Kugelhahnen INOXPRES 195/008 Inox M-Profil**

- Mit Schlauchanschluss
- Material: A-B: AISI 316L - 1.4404, Messing
- O-Ring: EPDM schwarz
- SVGW Nr.: 0007 - 4278



d mm	Z mm	Z1 mm	L1 mm	L2 mm	L mm	Orig. Nr.	Stück	Art.-Nr.	CHF Stück
15 x 3/4	67.5	64	72	151	131.5	195015008	1	448204500	157.65
22 x 1	73	75.5	80	151	148.5	195022008	1	448204510	194.75
									4482

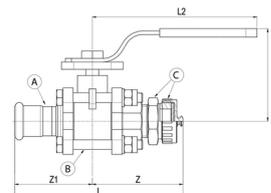

**Wellenkompensatoren INOXPRES 199 Inox M-Profil**

- Material: AISI 316L - 1.4404
- O-Ring: EPDM schwarz
- SVGW Nr.: 0007 - 4278

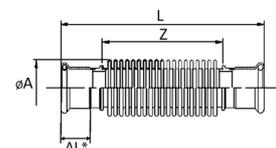

d mm	Anzahl Zyklen	Axialhub in Kompression mm	L mm	Z mm	A mm	Orig. Nr.	Stück	Art.-Nr.	CHF Stück
15	800	16	139	71	22	199015000	1	448204520	126.65
18	800	18	143	74	27	199018000	1	448204530	175.80
22	800	20	139	68	34	199022000	1	448204540	195.80
28	800	22	150	73	41	199028000	1	448204550	251.75
35	800	26	177	90	51	199035000	1	448204560	311.65
42	800	32	202	107	61	199042000	1	448204570	371.60
54	800	36	221	113	71	199054000	1	448204580	459.50
									4482

**Wellenkompensatoren INOXPRES 199 King Size Inox M-Profil**

- Material: AISI 316L - 1.4404
- O-Ring: EPDM schwarz
- SVGW Nr.: 0007 - 4278

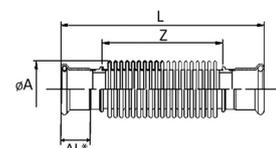

d mm	Anzahl Zyklen	Axialhub in Kompression mm	L mm	Z mm	A mm	Orig. Nr.	Stück	Art.-Nr.	CHF Stück
76.1	500	30	278	180	87	199076000	1	448501250	487.15
88.9	500	40	314	235	105	199088000	1	448501260	602.10
108	500	50	388	255	131	199108000	1	448501270	697.75
									4485

**Flexible Eckstücke INOXPRES 199/001**

- Material: AISI 316L - 1.4404 / AISI 304L - 1.4307
- O-Ring: EPDM schwarz

d mm	H1 mm	H2 mm	Z mm	L1 mm	L2 mm	Orig. Nr.	Stück	Art.-Nr.	CHF Stück
15	165	200	20	275	165	199015001	1	448204590	160.75
18	170	215	20	350	170	199018001	1	448204600	167.25
22	195	236	21	380	195	199022001	1	448204610	177.50
28	230	260	23	410	230	199028001	1	448204620	187.40
35	255	300	26	460	255	199035001	1	448204630	238.50
42	295	345	30	530	295	199042001	1	448204640	335.70
54	370	410	35	625	370	199054001	1	448204650	470.90
									4482

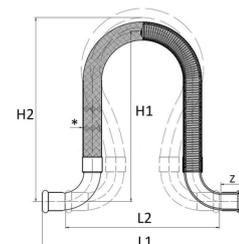
**Panzerschläuche INOXPRES 199/002**

- Material: AISI 316L - 1.4404 / AISI 304L - 1.4307
- O-Ring: EPDM schwarz

d mm	Z mm	L mm	Orig. Nr.	Stück	Art.-Nr.	CHF Stück
15	20	500	199015002	1	448204660	120.10
18	20	600	199018002	1	448204670	129.55
22	21	700	199022002	1	448204680	135.90
28	23	700	199028002	1	448204690	157.95
35	26	800	199035002	1	448204700	200.30
42	30	900	199042002	1	448204710	268.15
54	35	1100	199054002	1	448204720	404.60
						4482

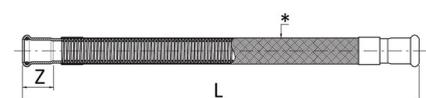

**Vernebler-Anschlüsse INOXPRES 195/007 U Inox M-Profil**

- Material: AISI 316L - 1.4404
- O-Ring: EPDM schwarz
- SVGW Nr.: 0007 - 4278

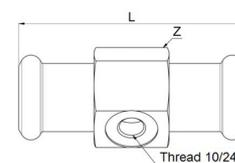

d mm	Z mm	Lochanzahl Stück	L mm	Orig. Nr.	Stück	Art.-Nr.	CHF Stück
15	24	1 x 10/24	60	195015017	10	448204730	14.85
15	24	2 x 10/24	60	195015027	10	448204740	16.80
							4482

**Vernebler INOXPRES 195/N**

- Material: AISI 304 - 1.4301
- O-Ring: braun
- SVGW Nr.: 0007 - 4278

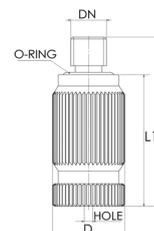

Düsenloch-Ø µm	DN Zoll	L1 mm	D mm	L mm	Orig. Nr.	Stück	Art.-Nr.	CHF Stück
15	10/24	20	9.5	25	195000015	10	448204750	44.10
20	10/24	20	9.5	25	195000020	10	448204760	34.70
30	10/24	20	9.5	25	195000030	10	448204770	28.05
40	10/24	20	9.5	25	195000040	10	448204780	28.05
50	10/24	20	9.5	25	195000050	10	448204790	28.05
							4482	

**Multitool-Anschlüsse INOXPRES 195/007 Inox M-Profil**

- Material: AISI 316L - 1.4404
- O-Ring: EPDM schwarz
- SVGW Nr.: 0007 - 4278

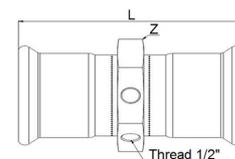

d mm	Z mm	Lochanzahl Stück	L mm	Orig. Nr.	Stück	Art.-Nr.	CHF Stück
35	60	3 x 1/2"	128	195035007	1	448204800	82.80
42	60	3 x 1/2"	135	195042007	1	448204810	94.50
54	74	3 x 1/2"	135	195054007	1	448204820	110.95
							4482

**Anschlüsse INOXPRES 195/007 King Size Inox M-Profil**

- Material: AISI 316L - 1.4404
- O-Ring: EPDM schwarz
- SVGW Nr.: 0007 - 4278



d mm	Z mm	Lochanzahl Stück	L mm	Orig. Nr.	Stück	Art.-Nr.	CHF Stück
76.1	92	3 x 1/2"	189	195076007	1	448501280	218.15
88.9	106	3 x 1/2"	208	195088007	1	448501290	254.50
108	130	3 x 1/2"	240	195108007	1	448501300	296.65
							4485

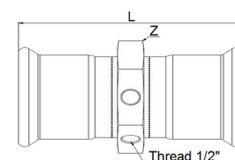

**Edelstahlrohre INOXPRES 116/030**

- Für Trinkwasser, Sanitär und Industrieanwendungen
- Material: AISI 444 - 1.4521
- Norm: EN 10217-7 (DIN 17455) - EN 10312
- SVGW Nr.: 0007 - 4278
- SVGW Nr.: 1911 - 6889



Abmessungen mm	Innen-Ø mm	Länge m	Volumen l / m	Orig. Nr.	⊞ m	Art.-Nr.	CHF m
15 x 1	13	6	0.133	116015030	60	448100100	9.15
18 x 1	16	6	0.201	116018030	60	448100110	10.55
22 x 1.2	19.6	6	0.302	116022030	60	448100120	15.20
28 x 1.2	25.6	6	0.514	116028030	30	448100130	19.55
35 x 1.5	32	6	0.804	116035030	30	448100140	29.45
42 x 1.5	39	6	1.194	116042030	30	448100150	35.80
54 x 1.5	51	6	2.042	116054030	30	448100160	45.90
							4481

**Edelstahlrohre INOXPRES 116/200**

- Für Trinkwasser, Sanitär-, Gas- und Industrieanwendungen
- Material: AISI 316L - 1.4404
- Norm: EN 10217-7 (DIN 17455) - EN 10312
- SVGW Nr.: 0007 - 4278
- SVGW Nr.: 1911 - 6889



Abmessungen mm	Innen-Ø mm	Länge m	Volumen l / m	Orig. Nr.	⊞ m	Art.-Nr.	CHF m
15 x 1	13	6	0.133	116015200	60	448000100	14.15
18 x 1	16	6	0.201	116018200	60	448000110	16.10
22 x 1.2	19.6	6	0.302	116022200	60	448000120	22.45
28 x 1.2	25.6	6	0.514	116028200	30	448000130	28.30
35 x 1.5	32	6	0.804	116035200	30	448000140	42.80
42 x 1.5	39	6	1.194	116042200	30	448000150	51.10
54 x 1.5	51	6	2.042	116054200	30	448000160	65.65
							4480



INOXPRES UNIKO

**Bögen INOXPRES Uniko 181/450 U Inox M/V-Profil**

- Material: AISI 316L - 1.4404
- O-Ring: EPDM schwarz / I/I
- SVGW Nr.: 1911 - 6889



d mm	Winkel °	Z mm	L mm	Orig. Nr.	Stück	Art.-Nr.	CHF Stück
15	45	14	36	181015450CU	20	448300100	12.20
18	45	15	37	181018450CU	20	448300110	13.50
22	45	17	41	181022450CU	20	448300120	15.65
28	45	23	47	181028450CU	10	448300130	18.85
35	45	19.5	47.5	181035450U	10	448300140	21.50
42	45	23	59	181042450U	4	448300150	34.80
54	45	28	69	181054450U	2	448300160	44.65
							4483

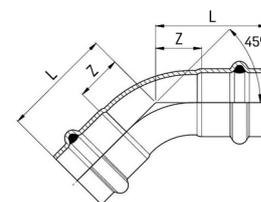

INOXPRES UNIKO

**Bögen INOXPRES Uniko 181/451 U Inox M/V-Profil**

- Material: AISI 316L - 1.4404
- O-Ring: EPDM schwarz / I/A
- SVGW Nr.: 1911 - 6889



d mm	Winkel °	H mm	Z mm	L mm	Orig. Nr.	Stück	Art.-Nr.	CHF Stück
15	45	49	14	36	181015451CU	20	448300170	12.20
18	45	45	15	37	181018451CU	20	448300180	13.05
22	45	48	17	41	181022451CU	20	448300190	14.80
28	45	55	23	47	181028451CU	10	448300200	17.60
35	45	57.5	19.5	47.5	181035451U	10	448300210	20.00
42	45	72	23	59	181042451U	4	448300220	33.45
54	45	78	28	69	181054451U	2	448300230	42.95
							4483	

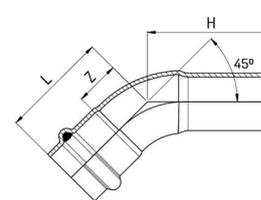

INOXPRES UNIKO

**Bögen INOXPRES Uniko 181/900U Inox M/V-Profil**

- Material: AISI 316L - 1.4404
- O-Ring: EPDM schwarz / I/I
- SVGW Nr.: 1911 - 6889



d mm	Winkel °	Z mm	L mm	Orig. Nr.	Stück	Art.-Nr.	CHF Stück
15	90	26	48	181015900CU	20	448300240	9.30
18	90	36	58	181018900CU	20	448300250	10.65
22	90	43	67	181022900CU	10	448300260	12.90
28	90	48	72	181028900CU	10	448300270	17.10
35	90	44	72	181035900U	5	448300280	26.75
42	90	52	88	181042900U	2	448300290	45.85
54	90	66	107	181054900U	2	448300300	64.00
							4483

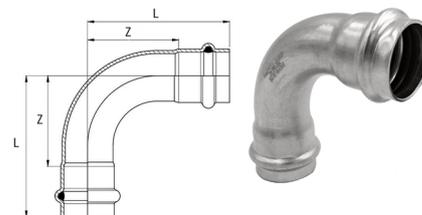

INOXPRES UNIKO

**Bögen INOXPRES Uniko 181/901U Inox M/V-Profil**

- Material: AISI 316L - 1.4404
- O-Ring: EPDM schwarz / I/A
- SVGW Nr.: 1911 - 6889



d mm	Winkel °	H mm	Z mm	L mm	Orig. Nr.	Stück	Art.-Nr.	CHF Stück
15	90	62.5	26	48	181015901CU	20	448300310	9.75
18	90	62	36	58	181018901CU	20	448300320	11.05
22	90	70	43	67	181022901CU	10	448300330	13.30
28	90	81	48	72	181028901CU	10	448300340	16.65
35	90	82	44	72	181035901U	5	448300350	24.50
42	90	100	52	88	181042901U	2	448300360	44.40
54	90	120	66	107	181054901U	2	448300370	64.35
							4483	

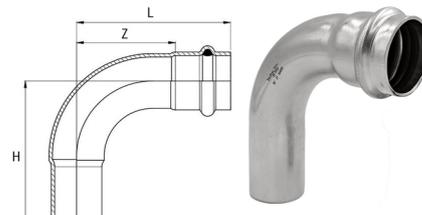



### Übergangswinkel INOXPRES Uniko 197U Inox M/V-Profil

- Mit Aussengewinde
- Material: AISI 316L - 1.4404
- Gewindenorm: EN 10226-1 (ex ISO 7/1)
- O-Ring: EPDM schwarz
- SVGW Nr.: 1911 - 6889



d mm	Winkel °	IG (R) Zoll	L1 mm	L2 mm	Z mm	Y mm	Orig. Nr.	Stück	Art.-Nr.	CHF Stück
15	90	1/2	44.5	42	20	22	197102015U	10	448300380	19.00
18	90	1/2	44.5	42	20	22	197102018U	10	448300390	21.75
22	90	3/4	49	45	21	27	197304022U	10	448300410	27.85
22	90	1/2	44.5	44	20	22	197102022U	10	448300400	24.85
28	90	3/4	49	45	21	27	197304028U	5	448300420	37.15
28	90	1	52.5	49	25	35	197100028U	5	448300430	36.50
										4483

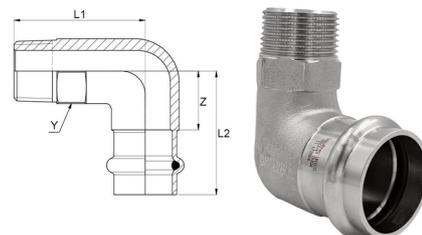

### Übergangswinkel INOXPRES Uniko 198U Inox M/V-Profil

- Mit Innengewinde
- Material: AISI 316L - 1.4404
- Gewindenorm: EN 10226-1 (ex ISO 7/1)
- O-Ring: EPDM schwarz
- SVGW Nr.: 1911 - 6889



d mm	IG (Rp) Zoll	Winkel °	L1 mm	L2 mm	Z1 mm	Y mm	Z2 mm	Orig. Nr.	Stück	Art.-Nr.	CHF Stück
15	1/2	90	33	44	15	27	22	198102015U	10	448300440	20.05
18	1/2	90	33	44	15	27	22	198102018U	10	448300450	23.00
22	1/2	90	33	46	15	27	22	198102022U	10	448300460	25.65
22	3/4	90	38	46	19	30	22	198304022U	10	448300470	28.10
28	1	90	48	51	21	40	27	198100028U	5	448300480	36.65
										4483	

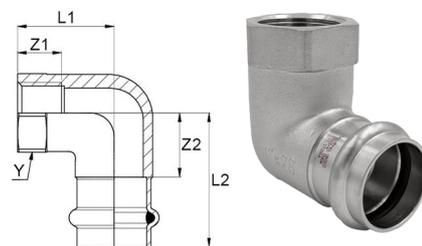

### Bögen INOXPRES Uniko 186/MU Inox M/V-Profil

- Mit Aussengewinde
- Material: AISI 316L - 1.4404
- Gewindenorm: EN 10226-1 (ex ISO 7/1)
- O-Ring: EPDM schwarz
- SVGW Nr.: 1911 - 6889



d mm	Winkel °	AG (R) Zoll	H mm	Z1 mm	Z mm	L mm	Orig. Nr.	Stück	Art.-Nr.	CHF Stück
15	90	1/2	54	26	24	48	186102015CU	20	448300490	28.50
18	90	1/2	59	36	24	58	186102018CU	20	448300500	29.90
22	90	3/4	69	43	30	67	186304022CU	10	448300510	34.90
28	90	1	80	48	36	72	186100028CU	10	448300520	41.40
										4483

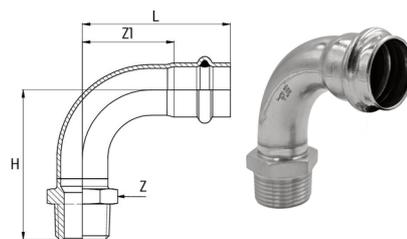

### Bögen INOXPRES Uniko 186/FU Inox M/V-Profil

- Mit Innengewinde
- Material: AISI 316L - 1.4404
- Gewindenorm: EN 10226-1 (ex ISO 7/1)
- O-Ring: EPDM schwarz
- SVGW Nr.: 1911 - 6889



d mm	Winkel °	IG (Rp) Zoll	H mm	Z1 mm	Z mm	L mm	Z2 mm	Orig. Nr.	Stück	Art.-Nr.	CHF Stück
15	90	1/2	60	26	24	48	45	186102015FCU	20	448300530	29.75
18	90	3/4	68	36	30	58	51.5	186304018FCU	10	448300540	35.50
										4483	

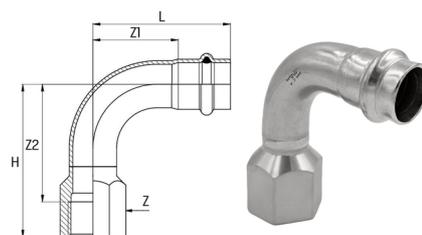



### T-Stücke INOXPRES Uniko 182U Inox M/V-Profil

- Material: AISI 316L - 1.4404
- O-Ring: EPDM schwarz
- SVGW Nr.: 1911 - 6889



d mm	L1 mm	L2 mm	Z1 mm	Z2 mm	Orig. Nr.	Stück	Art.-Nr.	CHF Stück
15	43	41	21	19	182015000U	20	448300620	16.75
18	45	43	23	21	182018000U	20	448300630	19.30
22	49	47.5	25	23.5	182022000U	10	448300640	20.25
28	52	51.5	28	27.5	182028000U	5	448300650	24.35
35	62	58.5	34	30.5	182035000U	4	448300660	30.35
42	75	70.5	39	34.5	182042000U	4	448300670	42.95
54	89	83.5	48	42.5	182054000U	2	448300680	51.25
								4483

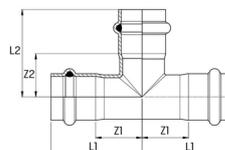

### T-Stücke INOXPRES Uniko 189 U Inox M/V-Profil

- Mit Innengewinde
- Material: AISI 316L - 1.4404
- Gewindenorm: EN 10226-1 (ex ISO 7/1)
- O-Ring: EPDM schwarz
- SVGW Nr.: 1911 - 6889



d mm	Rp Zoll	L1 mm	L2 mm	Z1 mm	Z2 mm	Orig. Nr.	Stück	Art.-Nr.	CHF Stück
15	1/2	38.5	22.5	16.5	8.5	189102015U	20	448300880	18.50
18	1/2	38	24	16	10	189102018U	20	448300890	19.00
18	3/4	42.5	30	20.5	14	189304018U	10	448300900	23.15
22	1/2	41	26	18	12	189102022U	10	448300910	20.30
22	3/4	43.5	30	20.5	14	189304022U	10	448300920	23.20
28	1/2	42	29	18	15	189102028U	10	448300930	22.35
28	3/4	45	30	21	14	189304028U	10	448300940	26.55
28	1	45	34	21	16	189100028U	5	448300950	42.00
35	1/2	62	50	34	35	189102035U	5	448300960	26.80
42	1/2	75	53.5	39	38.5	189102042U	4	448300970	32.50
54	1/2	89	61	48	46	189102054U	2	448300980	39.25
								4483	

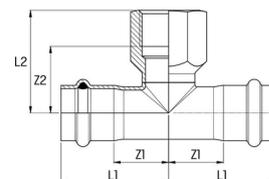

### T-Stücke INOXPRES Uniko 192 U Inox M/V-Profil

- Mit reduziertem Abgang
- Material: AISI 316L - 1.4404
- O-Ring: EPDM schwarz
- SVGW Nr.: 1911 - 6889



d mm	L1 mm	L2 mm	Z1 mm	Z2 mm	Orig. Nr.	Stück	Art.-Nr.	CHF Stück
18 x 15 x 18	45	42.5	23	20.5	192018015U	20	448300700	16.20
22 x 15 x 22	49	45	25	23	192022015U	10	448300710	17.00
22 x 18 x 22	49	45.5	25	23.5	192022018U	10	448300720	17.85
28 x 15 x 28	52	47.5	28	25.5	192028015U	10	448300730	20.25
28 x 18 x 28	52	48	28	26	192028018U	10	448300740	21.15
28 x 22 x 28	52	50	28	26	192028022U	10	448300750	22.55
35 x 15 x 35	62	51	34	29	192035015U	5	448300760	26.30
35 x 18 x 35	62	51.5	34	29.5	192035018U	5	448300770	26.70
35 x 22 x 35	62	53.5	34	29.5	192035022U	5	448300780	27.55
35 x 28 x 35	62	55	34	31	192035028U	5	448300790	28.65
42 x 18 x 42	75	55	39	33	192042018U	4	448300800	38.10
42 x 22 x 42	75	57	39	33	192042022U	4	448300810	39.45
42 x 28 x 42	75	58.5	39	34.5	192042028U	4	448300820	40.30
42 x 35 x 42	75	61	39	33	192042035U	4	448300830	41.25
54 x 22 x 54	89	64.5	48	40.5	192054022U	2	448300840	43.50
54 x 28 x 54	89	66	48	42	192054028U	2	448300850	45.30
54 x 35 x 54	89	68.5	48	40.5	192054035U	2	448300860	46.20
54 x 42 x 54	89	78	48	42	192054042U	2	448300870	49.50
								4483

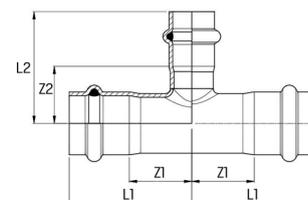



### T-Stücke INOXPRES Uniko 192/L U Inox M/V-Profil

- Mit reduziertem Abgang
- Material: AISI 316L - 1.4404
- O-Ring: EPDM schwarz
- SVGW Nr.: 1911 - 6889



d mm	L1 mm	L2 mm	L3 mm	Z1 mm	Z2 mm	Z3 mm	Orig. Nr.	Stück	Art.-Nr.	CHF Stück
18 x 15 x 15	43	43	41	21	21	19	192181515U	20	448300690	19.00 4483

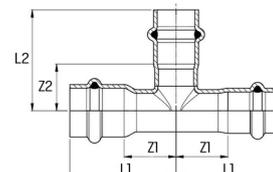

### Muffen INOXPRES Uniko 183/000U Inox M/V-Profil

- Material: AISI 316L - 1.4404
- O-Ring: EPDM schwarz
- SVGW Nr.: 1911 - 6889



d mm	Z mm	L mm	Orig. Nr.	Stück	Art.-Nr.	CHF Stück
15	13	57	183015000U	20	448300990	6.30
18	13	57	183018000U	20	448301000	7.15
22	11	59	183022000U	20	448301010	8.25
28	13	61	183028000U	10	448301020	9.40
35	14	70	183035000U	10	448301030	11.95
42	12	84	183042000U	4	448301040	16.15
54	10	92	183054000U	2	448301050	19.60 4483

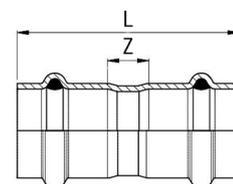

### Schiebemuffen INOXPRES Uniko 183/001U Inox M/V-Profil

- Material: AISI 316L - 1.4404
- O-Ring: EPDM schwarz
- SVGW Nr.: 1911 - 6889



d mm	es mm	L mm	Orig. Nr.	Stück	Art.-Nr.	CHF Stück
15	25	82	183015001U	20	448301060	12.45
18	25	86	183018001U	20	448301070	13.05
22	25	92	183022001U	20	448301080	15.10
28	30	101	183028001U	10	448301090	17.70
35	30	119	183035001U	5	448301100	22.70
42	40	135	183042001U	4	448301110	27.10
54	45	158	183054001U	2	448301120	37.40 4483

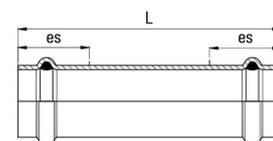

### Verschlusskappen INOXPRES Uniko 183/003U Inox M/V-Profil

- Material: AISI 316L - 1.4404
- O-Ring: EPDM schwarz
- SVGW Nr.: 1911 - 6889



d mm	L1 mm	L mm	Orig. Nr.	Stück	Art.-Nr.	CHF Stück
15	6	28	183015003U	20	448301290	8.90
18	6	28	183018003U	20	448301300	9.30
22	6	29	183022003U	10	448301310	10.75
28	6	30	183028003U	10	448301320	14.85
35	26.5	52.5	183035003U	5	448301330	16.95
42	26.5	62	183042003U	4	448301340	26.00
54	26.5	67.5	183054003U	4	448301350	30.35 4483

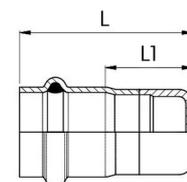



### Anschlussverschraubungen INOXPRES Uniko 183/002U Inox M/V-Profil

- Material: AISI 316L - 1.4404
- O-Ring / Dichtung: EPDM schwarz
- SVGW Nr.: 1911 - 6889



d mm	IG (G) Zoll	Z mm	Y mm	L mm	Orig. Nr.	Stück	Art.-Nr.	CHF Stück
15	1/2	27	23.0	50.0	183015012U	10	448301690	18.45
15	3/4	30	23.0	51.5	183015002U	10	448301700	18.65
18	1/2	27	22.5	50.0	183018012U	10	448301710	20.40
18	3/4	30	23.5	52.0	183018002U	10	448301720	20.40
22	3/4	30	22.0	52.5	183022012U	10	448301730	23.95
22	1	36	23.5	54.5	183022002U	10	448301740	23.95
28	1	36	22.5	53.5	183028012U	10	448301750	29.75
28	1 1/4	46	25.0	57.5	183028002U	10	448301760	29.75
35	1 1/2	52	27.0	63.0	183035002U	4	448301770	33.75
42	1 3/4	58	27.5	73.5	183042012U	2	448301780	45.55
54	2 3/8	75	28.5	82.5	183054012U	2	448301790	61.30
								4483

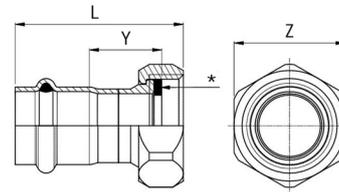

### Deckenwinkel INOXPRES Uniko 185/000U Inox M/V-Profil

- Material: AISI 316L - 1.4404 / A/I
- Gewindenorm: EN 10226-1 (ex ISO 7/1)
- O-Ring: EPDM schwarz
- SVGW Nr.: 1911 - 6889



d mm	IG (Rp) Zoll	Winkel °	L1 mm	L2 mm	Z1 mm	Z2 mm	A mm	B mm	D mm	Orig. Nr.	Stück	Art.-Nr.	CHF Stück
15	1/2	90	36	30	14	16.5	34	13	5	185102015U	10	448300550	22.55
18	1/2	90	36	30	14	16.5	34	13	5	185102018U	10	448300560	23.40
22	1/2	90	40	34	17	20.5	40	16	6	185102022U	10	448300570	34.80
22	3/4	90	42	34	19	19	40	17	6	185304022U	10	448300580	33.70
													4483

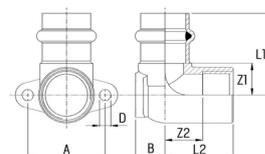

### Doppelwandscheiben INOXPRES Uniko 185/003U Inox M/V-Profil

- Material: AISI 316L - 1.4404
- Gewindenorm: EN 10226-1 (ex ISO 7/1)
- O-Ring: EPDM schwarz
- SVGW Nr.: 1911 - 6889



d mm	IG (Rp) Zoll	L1 mm	L2 mm	Z1 mm	Z2 mm	A mm	B mm	C mm	D mm	Orig. Nr.	Stück	Art.-Nr.	CHF Stück
15	1/2	64	30.5	42	17	40	12.5	50	6.2	185102315U	10	448300590	49.20
18	1/2	65.5	30	43.5	16.5	40	13	50	6.2	185102318U	5	448300600	50.75
22	1/2	75.5	27	51.5	13.5	40	16	60	6.2	185102322U	5	448300610	56.30
													4483

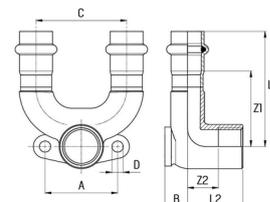



### Übergangsstücke INOXPRES Uniko 187U Inox M/V-Profil

- Mit Aussengewinde
- Material: AISI 316L - 1.4404
- Gewindenorm: EN 10226-1 (ex ISO 7/1)
- O-Ring: EPDM schwarz
- SVGW Nr.: 1911 - 6889



d mm	AG (R) Zoll	Z mm	Y mm	L mm	Orig. Nr.	Stück	Art.-Nr.	CHF Stück
15	1/2	24	21	42	187102015U	20	448301360	16.00
15	3/4	30	24	45	187304015U	20	448301370	16.20
18	1/2	27	21	42	187102018U	20	448301380	17.40
18	3/4	30	24	45	187304018U	20	448301390	18.15
22	1/2	32	24	46	187102022U	10	448301400	18.90
22	3/4	32	24	46	187304022U	10	448301410	19.55
22	1	36	27	49	187100022U	10	448301420	23.25
28	3/4	38	25	48	187304028U	10	448301430	26.65
28	1	38	27	50	187100028U	10	448301440	30.55
28	1 1/4	46	31	54	187114028U	10	448301450	35.30
35	1	45	27	54	187100035U	5	448301460	32.20
35	1 1/4	46	31	58	187114035U	5	448301470	37.40
35	1 1/2	50	31	58	187112035U	4	448301480	44.10
42	1 1/4	54	31	65	187114042U	4	448301490	50.15
42	1 1/2	54	31	65	187112042U	4	448301500	54.35
54	1 1/2	67	34	73	187112054U	4	448301510	63.10
54	2	67	39	78	187200054U	4	448301520	67.60
								4483

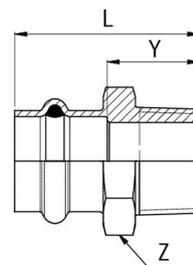

### Übergangsstücke INOXPRES Uniko 190U Inox M/V-Profil

- Mit Innengewinde
- Material: AISI 316L - 1.4404
- Gewinde: ISO 7/1 - ANSI B 1.20.1
- O-Ring: EPDM schwarz
- SVGW Nr.: 1911 - 6889



d mm	IG (Rp) Zoll	Z mm	Y mm	L mm	Orig. Nr.	Stück	Art.-Nr.	CHF Stück
15	1/2	27	2	40	190102015U	20	448301530	17.20
15	3/4	32	2	41	190304015U	20	448301540	17.95
18	1/2	27	2	40	190102018U	20	448301550	18.15
18	3/4	32	2	41	190304018U	10	448301560	19.00
22	1/2	32	2	40	190102022U	20	448301570	19.25
22	3/4	32	2	42	190304022U	10	448301580	22.60
22	1	41	2	46	190100022U	10	448301590	26.70
28	3/4	38	2	42	190304028U	10	448301600	25.90
28	1	41	2	47	190100028U	10	448301610	35.45
28	1 1/4	46	2	49	190114028U	10	448301620	39.35
35	1	46	2	51	190100035U	5	448301630	34.10
35	1 1/4	46	2	54	190114035U	5	448301640	38.70
42	1 1/2	55	2	60	190112042U	4	448301660	60.30
42	1 1/4	55	2	60	190114042U	4	448301650	43.75
54	1 1/2	67	1	63	190112054U	4	448301670	65.65
54	2	67	2	70	190200054U	4	448301680	89.80
								4483

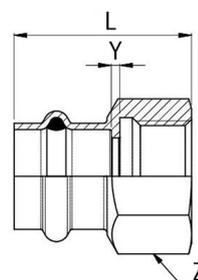



### Durchgangsschraubungen INOXPRES Uniko 184/001U Inox M/V-Profil

- Mit Pressenden flachdichtend
- Material: AISI 316L - 1.4404
- O-Ring / Dichtung: EPDM schwarz
- SVGW Nr.: 1911 - 6889



d mm	Z mm	Y mm	L mm	Orig. Nr.	Stück	Art.-Nr.	CHF Stück
15	34	56	100	184015001U	10	448301800	35.35
18	39	57	101	184018001U	10	448301810	41.85
22	39	57	105	184022001U	10	448301820	46.90
28	58	72	120	184028001U	5	448301830	60.90
35	67	71.5	127.5	184035001U	4	448301840	76.85
42	77	80	152	184042001U	2	448301850	95.25
54	90	83.5	165.5	184054001U	2	448301860	180.00
							4483

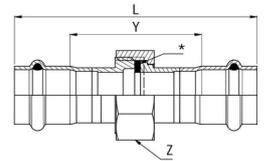

### Durchgangsschraubungen INOXPRES Uniko 184/002U Inox M/V-Profil

- Mit Aussengewinde, Anschlussmuffe Messing
- Material: AISI 316L - 1.4404
- Gewindenorm: EN 10226-1 (ex ISO 7/1)
- O-Ring / Dichtung: EPDM schwarz
- SVGW Nr.: 1911 - 6889



d mm	AG (R) Zoll	Z mm	L mm	Orig. Nr.	Stück	Art.-Nr.	CHF Stück
15	1/2	56.5	78.5	184015002U	2	448301870	31.55
18	1/2	57	79	184018002U	2	448301880	35.90
22	3/4	59.5	83.5	184022002U	2	448301890	37.00
28	1	67.5	91.5	184028002U	2	448301900	63.05
35	1 1/4	73	101	184035002U	2	448301910	80.45
42	1 1/2	74.5	110.5	184042002U	2	448301920	92.40
54	2	82	123	184054002U	2	448301930	158.75
							4483

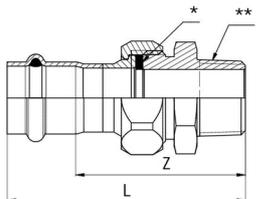

### Durchgangsschraubungen INOXPRES Uniko 184/003U Inox M/V-Profil

- Mit Innengewinde, Anschlussmuffe Messing
- Material: AISI 316L - 1.4404
- Gewindenorm: EN 10226-1 (ex ISO 7/1)
- O-Ring / Dichtung: EPDM schwarz
- SVGW Nr.: 1911 - 6889



d mm	IG (Rp) Zoll	Z mm	L mm	Orig. Nr.	Stück	Art.-Nr.	CHF Stück
15	1/2	51	73	184015003U	2	448302010	31.55
18	1/2	51.5	73.5	184018003U	2	448302020	38.00
22	3/4	54.5	78.5	184022003U	2	448302030	41.35
28	1	60	84	184028003U	2	448302040	54.40
35	1 1/4	65	93	184035003U	2	448302050	67.45
42	1 1/2	66.5	102.5	184042003U	2	448302060	83.80
54	2	80	121	184054003U	2	448302070	159.80
							4483

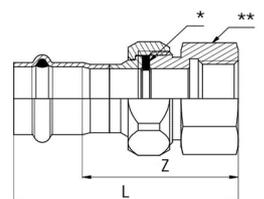



### Durchgangsverschraubungen INOXPRES Uniko 184/002U Inox M/V-Profil

- Mit Aussengewinde
- Material: AISI 316L - 1.4404
- Gewindenorm: EN 10226-1 (ex ISO 7/1)
- O-Ring / Dichtung: EPDM schwarz
- SVGW Nr.: 1911 - 6889



d mm	AG (R) Zoll	Z mm	L mm	Orig. Nr.	☞ Stück	Art.-Nr.	CHF Stück
15	1/2	56.5	78.5	184015002IU	2	448301940	39.45
18	1/2	57	79	184018002IU	2	448301950	44.90
22	3/4	59.5	83.5	184022002IU	2	448301960	47.35
28	1	67.5	91.5	184028002IU	2	448301970	78.85
35	1 1/4	73	101	184035002IU	2	448301980	100.60
42	1 1/2	74.5	110.5	184042002IU	2	448301990	106.30
54	2	82	123	184054002IU	2	448302000	182.60
							4483

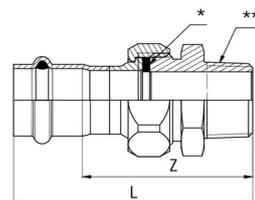

### Durchgangsverschraubungen INOXPRES Uniko 184/003U Inox M/V-Profil

- Mit Innengewinde, Anschlussmuffe Inox
- Material: AISI 316L - 1.4404
- Gewindenorm: EN 10226-1 (ex ISO 7/1)
- O-Ring / Dichtung: EPDM schwarz
- SVGW Nr.: 1911 - 6889



d mm	IG (Rp) Zoll	Z mm	L mm	Orig. Nr.	☞ Stück	Art.-Nr.	CHF Stück
15	1/2	51	73	184015003IU	2	448302080	39.45
18	1/2	51.5	73.5	184018003IU	2	448302090	47.50
22	3/4	54.5	78.5	184022003IU	2	448302100	52.45
28	1	60	84	184028003IU	2	448302110	67.95
35	1 1/4	65	93	184035003IU	2	448302120	84.30
42	1 1/2	66.5	102.5	184042003IU	2	448302130	96.35
54	2	80	121	184054003IU	2	448302140	183.85
							4483

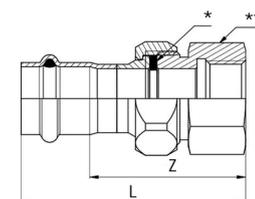

### Reduzierstücke INOXPRES Uniko 191U Inox M/V-Profil

- Material: AISI 316L - 1.4404
- O-Ring: EPDM schwarz
- SVGW Nr.: 1911 - 6889



d mm	Z mm	L mm	Orig. Nr.	☞ Stück	Art.-Nr.	CHF Stück
18 x 15	40.5	62.5	191018015U	20	448301130	7.30
22 x 15	56	78	191022015U	20	448301140	8.00
22 x 18	46.5	68.5	191022018U	20	448301150	8.25
28 x 15	56.5	78.5	191028015U	20	448301160	10.35
28 x 18	53	75	191028018U	20	448301170	9.65
28 x 22	47.5	71.5	191028022U	20	448301180	9.60
35 x 15	67	89	191035015U	10	448301190	35.45
35 x 18	67	89	191035018U	10	448301200	35.85
35 x 22	61.5	85.5	191035022U	10	448301210	30.15
35 x 28	55.5	79.5	191035028U	10	448301220	23.35
42 x 22	85.5	109.5	191042022U	4	448301230	38.05
42 x 28	79	103	191042028U	4	448301240	38.90
42 x 35	67	95	191042035U	4	448301250	25.35
54 x 28	86	110	191054028U	4	448301260	44.60
54 x 35	85.5	113.5	191054035U	4	448301270	55.55
54 x 42	75	111	191054042U	4	448301280	27.00
						4483

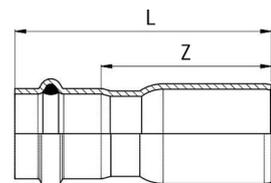



## Übergangsflansche INOXPRES Uniko 193/000U Inox M/V-Profil

- Material: AISI 316L - 1.4404
- O-Ring: EPDM schwarz
- PN 16
- SVGW Nr.: 1911 - 6889



De mm	DN fig	H mm	Z mm	B mm	D2 mm	Lochanzahl Stück	D mm	K mm	Orig. Nr.	Art.-Nr.	CHF Stück
22	20	61.5	37.5	16	14	4	105	75	193022000U	2 448302150	85.50
28	25	63	39	16	14	4	115	85	193028000U	2 448302160	104.50
35	32	65.5	37.5	16	18	4	140	100	193035000U	2 448302170	147.55
42	40	75	39	16	18	4	150	110	193042000U	2 448302180	173.05
54	50	82.5	41.5	18	18	4	165	125	193054000U	2 448302190	213.45
											4483

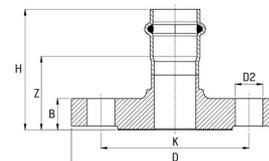



# 2



Heizung  
steelPRES



**Rohre STEELPRES 316/005 C-Stahl**

- Für Heizungs- und Industrieanwendungen, nicht geeignet für Trinkwasser
- Material: E 220 CR2S4 - 1.0215, aussen verzinkt
- Norm: EN 10305-3

Abmessungen mm	Innen-Ø mm	Länge m	Volumen l / m	Orig. Nr.	☞ m	Art.-Nr.	CHF m
12 x 1.2	9.6	6	0.072	316012005	150	358300100	3.95
15 x 1.2	12.6	6	0.125	316015005	120	358300110	4.35
18 x 1.2	15.6	6	0.191	316018005	90	358300120	4.75
22 x 1.5	19	6	0.284	316022005	60	358300130	7.25
28 x 1.5	25	6	0.491	316028005	60	358300140	9.55
35 x 1.5	32	6	0.804	316035005	30	358300150	12.20
42 x 1.5	39	6	1.194	316042005	30	358300160	14.25
54 x 1.5	51	6	2.042	316054005	30	358300170	19.85
							3583

**Rohre STEELPRES 316/005 King Size C-Stahl**

- Für Heizungs- und Industrieanwendungen, nicht geeignet für Trinkwasser
- Material: E 220 CR2S4 - 1.0215, aussen verzinkt
- Norm: EN 10305-3

Abmessungen mm	Innen-Ø mm	Länge m	Volumen l / m	Orig. Nr.	☞ m	Art.-Nr.	CHF m
76.1 x 2	72.1	6	4.080	316076005	12	358400100	42.75
88.9 x 2	84.9	6	5.660	316088005	12	358400110	53.10
108 x 2	104	6	8.490	316108005	6	358400120	65.15
							3584

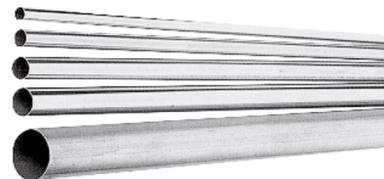
**Rohre STEELPRES 316/003 C-Stahl**

- Für Heizungs- und Industrieanwendungen, nicht geeignet für Trinkwasser
- Material: E 220 CR2S4 + PP - 1.0215, aussen verzinkt mit PP-Ummantelung 1 mm
- Norm: EN 10305-3

Abmessungen mm	Innen-Ø mm	Länge m	Volumen l / m	Orig. Nr.	☞ m	Art.-Nr.	CHF m
12 x 1.2	9.6	6	0.072	316012003	150	358300180	6.15
15 x 1.2	12.6	6	0.125	316015003	120	358300190	6.95
18 x 1.2	15.6	6	0.191	316018003	90	358300200	7.65
22 x 1.5	19	6	0.284	316022003	60	358300210	10.70
28 x 1.5	25	6	0.491	316028003	60	358300220	13.50
35 x 1.5	32	6	0.804	316035003	30	358300230	17.40
42 x 1.5	39	6	1.194	316042003	30	358300240	20.25
54 x 1.5	51	6	2.042	316054003	30	358300250	27.45
							3583

Kein Lagerartikel

**Rohre STEELPRES 316/003 King Size C-Stahl**

- Für Heizungs- und Industrieanwendungen, nicht geeignet für Trinkwasser
- Material: E 220 CR2S4 + PP - 1.0215, aussen verzinkt mit PP-Ummantelung 1 mm
- Norm: EN 10305-3

Abmessungen mm	Innen-Ø mm	Länge m	Volumen l / m	Orig. Nr.	☞ m	Art.-Nr.	CHF m
76.1 x 2	72.1	6	4.080	316076003	12	358400130	54.95
88.9 x 2	84.9	6	5.660	316088003	12	358400140	66.50
108 x 2	104	6	8.490	316108003	6	358400150	80.90
							3584

Kein Lagerartikel

**Bögen STEELPRES 381/450 C-Stahl M-Profil**

- Material: E 195 - 1.0034
- Aussen galvanisch verzinkt
- O-Ring: EPDM schwarz

d mm	Winkel °	L mm	Z mm	Orig. Nr.	☞ Stück	Art.-Nr.	CHF Stück
15	45	27.5	7.5	381015450	20	358100310	3.80
18	45	29.5	9.5	381018450	20	358100320	4.10
22	45	32	11	381022450	20	358100330	4.25
28	45	37	14	381028450	10	358100340	5.80
35	45	43	17	381035450	10	358100350	10.95
42	45	51	21	381042450	4	358100360	13.90
54	45	62	30	381054450	2	358100370	16.25
							3581

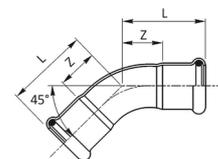

**Bögen STEELPRES 381/450 King Size C-Stahl M-Profil**

- Material: E 195 - 1.0034
- Aussen galvanisch verzinkt I/I
- O-Ring: EPDM schwarz

d mm	Winkel °	L mm	Z mm	Orig. Nr.	Stück	Art.-Nr.	CHF Stück
76.1	45	131.5	76.5	381076450	2	358200130	49.55
88.9	45	144	84	381088450	2	358200140	71.70
108	45	169	94	381108450	2	358200150	88.50
							3582

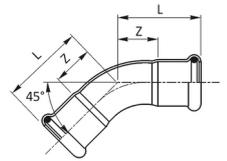
**Bögen STEELPRES 381/451 C-Stahl M-Profil**

- Material: E 195 - 1.0034
- Aussen galvanisch verzinkt I/A
- O-Ring: EPDM schwarz

d mm	Winkel °	L mm	Z mm	H mm	Orig. Nr.	Stück	Art.-Nr.	CHF Stück
15	45	27.5	7.5	36	381015451	20	358100380	3.80
18	45	29.5	9.5	38	381018451	20	358100390	3.95
22	45	32	11	42	381022451	20	358100400	4.10
28	45	37	14	46	381028451	10	358100410	6.05
35	45	43	17	57	381035451	10	358100420	10.80
42	45	51	21	72	381042451	4	358100430	13.75
54	45	62	30	82	381054451	2	358100440	16.15
							3581	

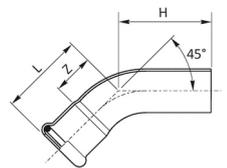
**Bögen STEELPRES 381/451 King Size C-Stahl M-Profil**

- Material: E 195 - 1.0034
- Aussen galvanisch verzinkt I/A
- O-Ring: EPDM schwarz

d mm	Winkel °	L mm	Z mm	H mm	Orig. Nr.	Stück	Art.-Nr.	CHF Stück
76.1	45	131.5	76.5	149	381076451	2	358200160	47.50
88.9	45	144	84	159	381088451	2	358200170	69.55
108	45	169	94	199	381108451	2	358200180	88.20
							3582	

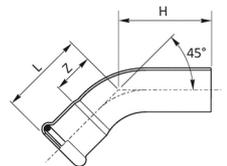
**Bögen STEELPRES 381/900 C-Stahl M-Profil**

- Material: E 195 - 1.0034
- Aussen galvanisch verzinkt / I/I
- O-Ring: EPDM schwarz

d mm	Winkel °	L mm	Z mm	Orig. Nr.	Stück	Art.-Nr.	CHF Stück
12	90	42	24	381012900	20	358100520	3.60
15	90	38	18	381015900	20	358100530	3.25
18	90	41.5	21.5	381018900	20	358100540	3.50
22	90	47	26	381022900	10	358100550	4.05
28	90	56	33	381028900	10	358100560	5.55
35	90	68	42	381035900	5	358100570	11.95
42	90	80	50	381042900	2	358100580	19.80
54	90	100	64	381054900	2	358100590	23.55
							3581

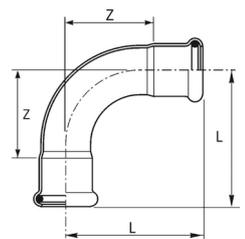

**Bögen STEELPRES 381/900 King Size C-Stahl M-Profil**

- Material: E 195 - 1.0034
- Aussen galvanisch verzinkt I/I
- O-Ring: EPDM schwarz

d mm	Winkel °	L mm	Z mm	Orig. Nr.	Stück	Art.-Nr.	CHF Stück
76.1	90	160	105	381076900	2	358200190	51.35
88.9	90	182	122	381088900	2	358200200	70.80
108	90	220	145	381108900	2	358200210	95.60
							3582

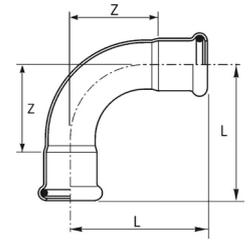
**Bögen STEELPRES 381/901 C-Stahl M-Profil**

- Material: E 195 - 1.0034
- Aussen galvanisch verzinkt I/A
- O-Ring: EPDM schwarz

d mm	Winkel °	L mm	Z mm	H mm	Orig. Nr.	Stück	Art.-Nr.	CHF Stück
12	90	42	24	48	381012901	20	358100600	3.95
15	90	38	18	48	381015901	20	358100610	3.55
18	90	41.5	21.5	48.5	381018901	20	358100620	3.85
22	90	47	26	57	381022901	10	358100630	4.40
28	90	56	33	64	381028901	10	358100640	5.50
35	90	68	42	82	381035901	5	358100650	11.95
42	90	80	50	101	381042901	2	358100660	20.30
54	90	100	64	120	381054901	2	358100670	24.20
							3581	

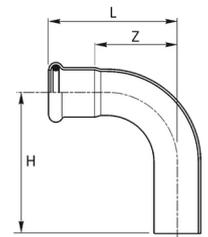
**Bögen STEELPRES 381/901 King Size C-Stahl M-Profil**

- Material: E 195 - 1.0034
- Aussen galvanisch verzinkt I/A
- O-Ring: EPDM schwarz

d mm	Winkel °	L mm	Z mm	H mm	Orig. Nr.	Stück	Art.-Nr.	CHF Stück
76.1	90	160	105	180	381076901	2	358200220	48.30
88.9	90	182	122	197	381088901	2	358200230	76.35
108	90	220	145	236	381108901	2	358200240	93.30
							3582	

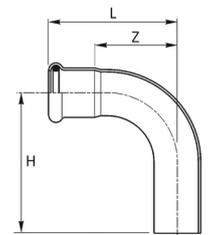
**Übergangswinkel STEELPRES 385 C-Stahl M-Profil**

- Mit Aussengewinde
- Material: E 195 - 1.0034
- Aussen galvanisch verzinkt
- O-Ring: EPDM schwarz

d mm	AG (R) Zoll	Winkel °	L mm	Z mm	H mm	Orig. Nr.	Stück	Art.-Nr.	CHF Stück
15	3/8	90	36	16	21	385308015	20	358100680	10.75
15	1/2	90	37	17	26	385102015	20	358100690	11.10
18	1/2	90	37	17	26	385102018	10	358100700	12.05
22	3/4	90	41	20	29	385304022	10	358100710	14.40
							3581		

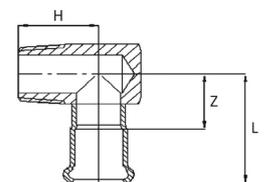

**Übergangswinkel STEELPRES 398 C-Stahl M-Profil**

- Mit Innengewinde
- Material: E 195 - 1.0034
- Aussen galvanisch verzinkt
- O-Ring: EPDM schwarz

d mm	IG (Rp) Zoll	Winkel °	L mm	Z1 mm	Z mm	H mm	Orig. Nr.	Stück	Art.-Nr.	CHF Stück
22	3/4	90	46	27	25	44	398304022	10	358100720	21.05
28	1/2	90	49	27	26	42	398102028	10	358100730	21.35
28	3/4	90	49	30	26	47	398304028	10	358100740	21.35
										3581

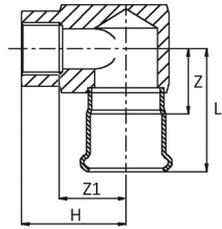

**Übergangsbogen STEELPRES 397 C-Stahl M-Profil**

- Mit Aussengewinde
- Material: E 195 - 1.0034
- Aussen galvanisch verzinkt
- O-Ring: EPDM schwarz

d mm	AG (Rp) Zoll	Winkel °	L mm	Z1 mm	Z mm	H mm	Orig. Nr.	Stück	Art.-Nr.	CHF Stück
12	3/8	90	42	24	22	34	397308012	20	358100750	10.65
15	3/8	90	50	30	21	47.5	397308015	20	358100760	9.80
15	1/2	90	50	30	21	47	397102015	20	358100770	10.15
18	1/2	90	54	34	24	52	397102018	20	358100780	11.05
22	3/4	90	60	39	30	62	397304022	10	358100790	13.60
28	1	90	73	50	36	74	397100028	10	358100800	17.00
35	1 1/4	90	68	42	46	80	397114035	5	358100810	27.80
42	1 1/2	90	80	50	60	98	397112042	2	358100820	42.75
54	2	90	100	65	65	131.5	397200054	2	358100830	61.65
										3581

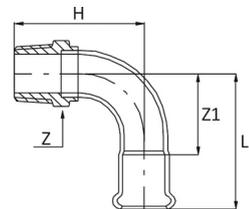

**T-Stücke STEELPRES 382 C-Stahl M-Profil**

- Material: E 195 - 1.0034
- Aussen galvanisch verzinkt
- O-Ring: EPDM schwarz

d mm	L1 mm	L2 mm	Z1 mm	Z2 mm	Orig. Nr.	Stück	Art.-Nr.	CHF Stück	
12	28	35	10	17.0	382012000	20	358100840	8.15	
15	32	32	10.5	10.5	382015000	20	358100850	7.65	
18	34	34	12.5	12.5	382018000	20	358100860	8.10	
22	37	37	14.5	14.5	382022000	20	358100870	8.45	
28	42	42	17.5	17.5	382028000	10	358100880	10.80	
35	50	50	22.5	22.5	382035000	4	358100890	17.15	
42	57	57	25.5	25.5	382042000	4	358100900	24.95	
54	69	69	32.5	32.5	382054000	2	358100910	29.90	
									3581

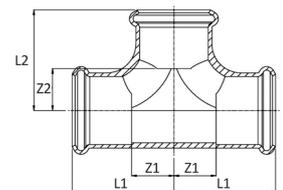

**T-Stücke STEELPRES 382 King Size C-Stahl M-Profil**

- Material: E 195 - 1.0034
- Aussen galvanisch verzinkt
- O-Ring: EPDM schwarz

d mm	L1 mm	L2 mm	Z1 mm	Z2 mm	Orig. Nr.	Stück	Art.-Nr.	CHF Stück	
76.1	108	118	52	63	382076000	2	358200250	110.70	
88.9	132	131	72	71	382088000	2	358200260	127.10	
108	155	159	74	84	382108000	2	358200270	160.60	
									3582

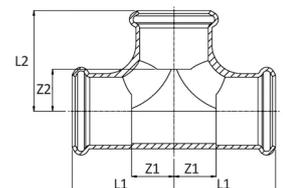

**T-Stücke STEELPRES 392 C-Stahl M-Profil**

- Mit reduziertem Abgang
- Material: E 195 - 1.0034
- Aussen galvanisch verzinkt
- O-Ring: EPDM schwarz

d mm	L1 mm	L2 mm	Z1 mm	Z2 mm	Orig. Nr.	☞ Stück	Art.-Nr.	CHF Stück
15 x 12 x 15	37	33	16	15	392015012	20	358100920	9.40
18 x 12 x 18	40	34	19	16	392018012	20	358100930	9.50
18 x 15 x 18	34	35	12.5	13.5	392018015	20	358100940	9.30
22 x 12 x 22	41	36	18	18	392022012	10	358100950	12.45
22 x 15 x 22	37	38	14.5	16.5	392022015	10	358100960	9.85
22 x 18 x 22	37	38	14.5	16	392022018	10	358100970	10.10
28 x 15 x 28	42	40.5	17.5	19	392028015	10	358100980	12.75
28 x 18 x 28	42	40.5	17.5	19	392028018	10	358100990	13.20
28 x 22 x 28	42	41	17.5	20	392028022	10	358101000	13.90
35 x 15 x 35	50	44	24	24	392035015	5	358101010	17.95
35 x 18 x 35	50	44	24	24	392035018	5	358101020	19.20
35 x 22 x 35	50	44	22.5	23	392035022	5	358101030	19.55
35 x 28 x 35	50	44	22.5	19.5	392035028	5	358101040	19.80
42 x 22 x 42	57	53	25.5	30.5	392042022	4	358101050	24.55
42 x 28 x 42	57	56	25.5	38	392042028	4	358101060	25.15
42 x 35 x 42	57	61	25.5	33.5	392042035	4	358101070	26.15
54 x 22 x 54	69	59	32.5	36.5	392054022	2	358101080	29.20
54 x 28 x 54	69	64	32.5	39.5	392054028	2	358101090	29.80
54 x 35 x 54	69	67	32.5	39.5	392054035	2	358101100	30.55
54 x 42 x 54	69	70	32.5	38.5	392054042	2	358101110	32.40
								3581

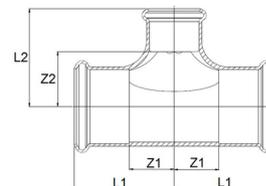
**T-Stücke STEELPRES 392 King Size C-Stahl M-Profil**

- Mit reduziertem Abgang
- Material: E 195 - 1.0034
- Aussen galvanisch verzinkt
- O-Ring: EPDM schwarz

d mm	L1 mm	L2 mm	Z1 mm	Z2 mm	Orig. Nr.	☞ Stück	Art.-Nr.	CHF Stück
76.1 x 22 x 76.1	108	74	52	53	392076022	2	358200280	100.70
76.1 x 28 x 76.1	108	77	52	54	392076028	2	358200290	101.90
76.1 x 35 x 76.1	108	80	52	54	392076035	2	358200300	104.10
76.1 x 42 x 76.1	108	84	52	54	392076042	2	358200310	106.25
76.1 x 54 x 76.1	108	90	52	55	392076054	2	358200320	107.40
88.9 x 28 x 88.9	132	84	72	61	392088028	2	358200330	110.60
88.9 x 35 x 88.9	132	88	72	62	392088035	2	358200340	112.80
88.9 x 42 x 88.9	132	91	72	61	392088042	2	358200350	117.10
88.9 x 54 x 88.9	132	97	72	62	392088054	2	358200360	121.45
88.9 x 76.1 x 88.9	132	125	72	70	392088076	2	358200370	126.30
108 x 28 x 108	155	94	74	71	392108028	2	358200380	135.55
108 x 35 x 108	155	97	74	71	392108035	2	358200390	138.80
108 x 42 x 108	155	101	74	71	392108042	2	358200400	140.95
108 x 54 x 108	155	107	74	72	392108054	2	358200410	143.15
108 x 76 x 108	155	135	74	80	392108076	2	358200420	147.45
108 x 88.9 x 108	155	141	74	81	392108088	2	358200430	157.85
								3582

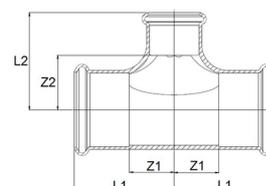
**T-Stücke STEELPRES 392/A C-Stahl M-Profil**

- Mit erweitertem Abgang
- Material: E 195 - 1.0034
- Aussen galvanisch verzinkt
- O-Ring: EPDM schwarz

d mm	L1 mm	L2 mm	Z1 mm	Z2 mm	Orig. Nr.	☞ Stück	Art.-Nr.	CHF Stück
12 x 15 x 12	28	38	10	17	392012015	20	358101120	15.05
15 x 18 x 15	37	36	16	15	392015018	20	358101130	16.25
15 x 22 x 15	37	42	16	19	392015022	10	358101140	18.15
18 x 22 x 18	40	45	19	22	392018022	10	358101150	18.50
22 x 28 x 22	41	45	18	21	392022028	10	358101160	19.25
								3581

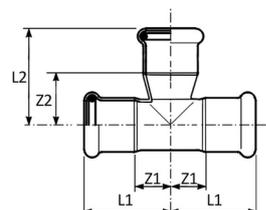

**Kreuzstücke STEELPRES 399 C-Stahl M-Profil**

- Material: E 195 - 1.0034
- Aussen galvanisch verzinkt
- O-Ring: EPDM schwarz

d1-d2 mm	Winkel °	L1 mm	L2 mm	Z1 mm	Z2 mm	H mm	Orig. Nr.	Stück	Art.-Nr.	CHF Stück
15 x 15	90	34.5	34.5	14.5	14.5	20	399015015	10	358101320	30.40
18 x 15	90	36.5	34.5	16.5	14.5	21.5	399018015	10	358101330	33.35
22 x 15	90	39.5	34.5	18.5	14.5	24	399022015	10	358101340	34.95
22 x 18	90	39.5	36.5	18.5	16.5	25.5	399022018	10	358101350	35.45
28 x 15	90	44	34.5	21	14.5	26.5	399028015	10	358101360	36.85
28 x 18	90	44	36.5	21	16.5	28	399028018	10	358101370	37.35
										3581

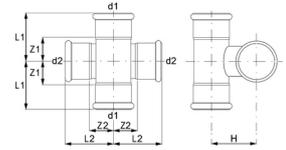

**T-Stücke STEELPRES 389 C-Stahl M-Profil**

- Mit Abgang Innengewinde
- Material: E 195 - 1.0034
- Aussen galvanisch verzinkt
- O-Ring: EPDM schwarz

d mm	IG (Rp) Zoll	L1 mm	L2 mm	Z1 mm	Z2 mm	Orig. Nr.	Stück	Art.-Nr.	CHF Stück	
15	1/2	34.5	36	14	21	389102015	20	358101170	10.50	
18	1/2	36.5	38	16	23	389102018	20	358101180	10.50	
22	1/2	39	39	18	24	389102022	10	358101190	11.10	
22	3/4	39	44	18	28	389304022	10	358101200	14.10	
28	1/2	44	42	21	27	389102028	10	358101210	13.15	
28	3/4	44	47	21	30	389304028	10	358101220	14.40	
28	1	44	52.5	21	34	389100028	5	358101230	18.60	
35	1/2	51	45	25	30	389102035	5	358101240	16.45	
35	3/4	51	50	25	34	389304035	5	358101250	21.70	
35	1	51	56	25	37	389100035	5	358101260	23.25	
42	1/2	59	49	28	34	389102042	4	358101270	24.65	
42	3/4	59	54	28	37	389304042	4	358101280	28.85	
54	1/2	70	56	34	41	389102054	2	358101290	28.50	
54	3/4	70	61	34	45	389304054	2	358101300	30.30	
54	1	70	56	34	41	389100054	2	358101310	45.05	
										3581

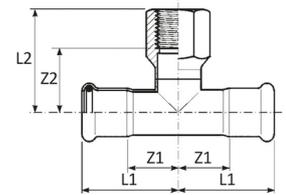

**T-Stücke STEELPRES 389 King Size C-Stahl M-Profil**

- Mit Abgang Innengewinde
- Material: E 195 - 1.0034
- Aussen galvanisch verzinkt
- O-Ring: EPDM schwarz

d mm	IG (Rp) Zoll	L1 mm	L2 mm	Z1 mm	Z2 mm	Orig. Nr.	Stück	Art.-Nr.	CHF Stück	
76.1	1/2	108	68	52	53	389102076	2	358200440	131.30	
76.1	3/4	108	77	52	60	389304076	2	358200450	135.10	
88.9	1/2	132	76	72	61	389102088	2	358200460	143.55	
88.9	3/4	132	84	72	68	389304088	2	358200470	147.35	
108	1/2	155	85	74	70	389102108	2	358200480	178.55	
108	3/4	155	94	74	77	389304108	2	358200490	184.20	
										3582

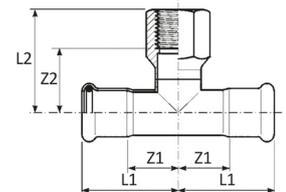

**Muffen STEELPRES 383/000 C-Stahl M-Profil**

- Material: E 195 - 1.0034
- Aussen galvanisch verzinkt
- O-Ring: EPDM schwarz

d mm	L mm	Z mm	Orig. Nr.	☞ Stück	Art.-Nr.	CHF Stück
12	42	6	383012000	20	358101380	2.80
15	49	9	383015000	20	358101390	2.40
18	50	10	383018000	20	358101400	2.50
22	53	11	383022000	20	358101410	2.80
28	56	10	383028000	10	358101420	3.40
35	63	10	383035000	10	358101430	5.65
42	72	12	383042000	4	358101440	7.65
54	83	13	383054000	2	358101450	9.10
						3581

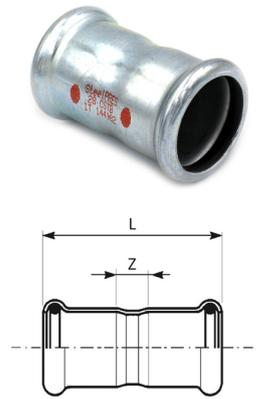
**Muffen STEELPRES 383/000 King Size C-Stahl M-Profil**

- Material: E 195 - 1.0034
- Aussen galvanisch verzinkt
- O-Ring: EPDM schwarz

d mm	L mm	Z mm	Orig. Nr.	☞ Stück	Art.-Nr.	CHF Stück
76.1	142	32	383076000	4	358200500	28.30
88.9	166	46	383088000	4	358200510	35.60
108	203	41	383108000	2	358200520	47.50
						3582

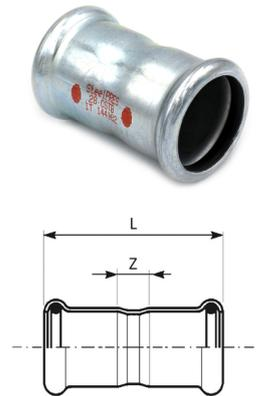
**Schiebemuffen STEELPRES 383/001 C-Stahl M-Profil**

- Material: E 195 - 1.0034
- Aussen galvanisch verzinkt
- O-Ring: EPDM schwarz

d mm	es mm	L mm	Orig. Nr.	☞ Stück	Art.-Nr.	CHF Stück
12	22	56	383012001	20	358101460	3.45
15	25	69	383015001	20	358101470	3.40
18	25	73	383018001	20	358101480	3.80
22	25	79	383022001	20	358101490	4.05
28	30	88.5	383028001	10	358101500	5.00
35	30	102.5	383035001	10	358101510	10.55
42	40	117.5	383042001	4	358101520	12.35
54	40	139	383054001	4	358101530	14.00
						3581

**Schiebemuffen STEELPRES 383/001 King Size C-Stahl M-Profil**

- Material: E 195 - 1.0034
- Aussen galvanisch verzinkt
- O-Ring: EPDM schwarz

d mm	es mm	L mm	Orig. Nr.	☞ Stück	Art.-Nr.	CHF Stück
76.1	60	230	383076001	2	358200530	43.85
88.9	70	260	383088001	2	358200540	58.65
108	80	310	383108001	2	358200550	63.25
						3582



**Anschlussverschraubungen STEELPRES 383/002 C-Stahl M-Profil**

- Material: E 195 - 1.0034
- Aussen galvanisch verzinkt
- Flach dichtend
- Lösbar mit Innengewinde
- O-Ring / Dichtung: EPDM schwarz

d mm	IG (G) Zoll	L mm	Y mm	Z mm	Dichtung	Orig. Nr.	Stück	Art.-Nr.	CHF Stück
15	3/4	37	10	30	24x14 thk 2.5	383015002	10	358102240	8.85
18	3/4	37	10	30	24x14 thk 2.5	383018002	10	358102250	9.15
22	3/4	54	25	30	24x14 thk 2.5	383022012	10	358102260	10.05
22	1	40	10	36	30x20 thk 2.5	383022002	10	358102270	9.75
22	1 1/2	42.5	14	55	44.5x30 thk 2.5	383022022	10	358102280	9.90
28	1	58	27	36	30x20 thk 2.5	383028012	10	358102290	13.30
28	1 1/4	47	14	46	39x27 thk 2.5	383028002	10	358102300	13.25
28	1 1/2	48	14	55	44.5x30 thk 2.5	383028022	10	358102310	14.10
35	1 1/4	67	32	46	39x27 thk 2.5	383035012	4	358102320	17.65
35	1 1/2	52	14	55	44.5x30 thk 2.5	383035002	4	358102330	17.65
42	1 1/2	77	35	55	44.5x30 thk 2.5	383042022	2	358102340	25.10
42	1 3/4	55	14	60	50.5x38 thk 2.5	383042002	2	358102350	25.10
42	2	56	14.5	65	56x42 thk 2.5	383042012	2	358102360	25.10
54	2	83	36.5	65	56x42 thk 2.5	383054012	2	358102370	35.30
54	2 3/8	60	15	75	65.5x45 thk 3.0	383054002	2	358102380	35.45
54	2 1/2	65.5	16	81	71.5x53 thk 3.0	383054022	2	358102390	42.95
									3581

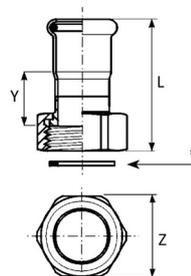
**Verschlusskappen STEELPRES 383/003 C-Stahl M-Profil**

- Material: E 195 - 1.0034
- Aussen galvanisch verzinkt
- O-Ring: EPDM schwarz

d mm	L mm	L1 mm	Orig. Nr.	Stück	Art.-Nr.	CHF Stück
12	30	13	383012003	20	358101720	5.75
15	26	5	383015003	20	358101730	4.80
18	26	5	383018003	10	358101740	5.15
22	27	5	383022003	10	358101750	5.70
28	29	5	383028003	10	358101760	7.55
35	32	5	383035003	5	358101770	9.10
42	36	5	383042003	4	358101780	14.15
54	41	5	383054003	4	358101790	17.20
						3581

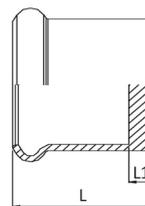
**Verschlusskappen STEELPRES 383/003 King Size C-Stahl M-Profil**

- Material: E 195 - 1.0034
- Aussen galvanisch verzinkt
- O-Ring: EPDM schwarz

d mm	L mm	L1 mm	Orig. Nr.	Stück	Art.-Nr.	CHF Stück
76.1	78	6	383076003	2	358200620	34.45
88.9	88	6	383088003	2	358200630	42.50
108	102	6	383108003	2	358200640	59.35
						3582

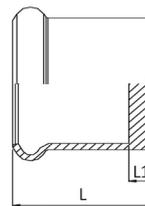
**Durchgangverschraubungen STEELPRES 384/000 C-Stahl M-Profil**

- Mit Aussengewinde, Anschlussmuffe Messing\*\*
- Material: E 195 - 1.0034
- Flach dichtend, lösbar
- Aussen galvanisch verzinkt
- O-Ring / Dichtung: EPDM schwarz\*

d mm	AG (R) Zoll	L mm	Z mm	Dichtung	Orig. Nr.	Stück	Art.-Nr.	CHF Stück
15	1/2	64	44	24x14 thk 2.5	384015000	2	358102400	17.60
18	1/2	64	44	24x14 thk 2.5	384018000	2	358102410	20.40
22	3/4	69	46	30x20 thk 2.5	384022000	2	358102420	23.60
28	1	80	56	39x27 thk 2.5	384028000	2	358102430	26.75
35	1 1/4	89	62	44.5x30 thk 2.5	384035000	2	358102440	36.90
42	1 1/2	93	61	50.5x38 thk 2.5	384042000	2	358102450	56.40
54	2	104	66	65.5x45 thk 3.0	384054000	2	358102460	128.30
								3581

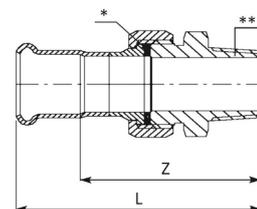

**Durchgangverschraubungen STEELPRES 384/001 C-Stahl M-Profil**

- Mit Aussengewinde, Anschlussmuffe Messing\*\*
- Material: E 195 - 1.0034
- Aussen galvanisch verzinkt
- Flach dichtend, lösbar
- O-Ring / Dichtung: EPDM schwarz\*

d mm	IG (Rp) Zoll	L mm	Z mm	Dichtung	Orig. Nr.	☞ Stück	Art.-Nr.	CHF Stück
15	1/2	59	38	24x14 thk 2.5	384015001	2	358102470	21.50
18	1/2	59	38	24x14 thk 2.5	384018001	2	358102480	22.40
22	3/4	64	41	30x20 thk 2.5	384022001	2	358102490	26.15
28	1	73	49	39x27 thk 2.5	384028001	2	358102500	37.20
35	1 1/4	81	54	44.5x30 thk 2.5	384035001	2	358102510	48.20
42	1 1/2	85	53	50.5x38 thk 2.5	384042001	2	358102520	71.30
54	2	102	66	65.5x45 thk 3	384054001	2	358102530	90.40
								3581

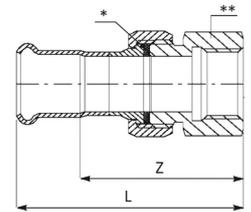
**Übergänge STEELPRES 387 C-Stahl M-Profil**

- Mit Aussengewinde
- Material: E 195 - 1.0034
- Aussen galvanisch verzinkt
- O-Ring: EPDM schwarz

d mm	AG (R) Zoll	L mm	Z mm	Y mm	Orig. Nr.	☞ Stück	Art.-Nr.	CHF Stück
12	3/8	38	19	21	387308012	20	358101800	6.75
15	3/8	41	24	21	387308015	20	358101810	6.80
15	3/4	44	27	24	387304015	10	358101830	7.00
15	1/2	44	24	24	387102015	20	358101820	6.80
18	1/2	44	27	24	387102018	20	358101840	7.00
18	3/4	45	30	25	387304018	10	358101850	8.20
22	1/2	42	32	21	387102022	10	358101860	7.85
22	3/4	45	32	25	387304022	10	358101870	7.85
22	1	46	36	25	387100022	10	358101880	8.80
28	3/4	47	38	24	387304028	10	358101890	9.50
28	1	48	38	25	387100028	10	358101900	9.80
28	1 1/4	52	46	29	387114028	5	358101910	10.60
35	1	52	46	25	387100035	5	358101920	12.40
35	1 1/4	56	46	29	387114035	5	358101930	12.65
35	1 1/2	55	50	28	387112035	5	358101940	13.40
42	1 1/2	63	55	33	387112042	4	358101950	14.40
54	2	72	65	36	387200054	4	358101960	22.80
								3581

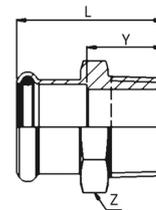
**Übergänge STEELPRES 387 King Size C-Stahl M-Profil**

- Mit Aussengewinde
- Material: E 195 - 1.0034
- Aussen galvanisch verzinkt
- O-Ring: EPDM schwarz

d mm	AG (R) Zoll	L mm	Z mm	Y mm	Orig. Nr.	☞ Stück	Art.-Nr.	CHF Stück
76.1	2 1/2	98	83	43	387212076	2	358200650	97.70
88.9	3	111	98	51	387300088	2	358200660	146.15
108	4	132	118	57	387400108	2	358200670	159.10
								3582

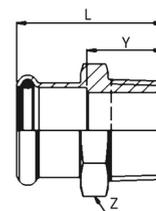

**Übergänge STEELPRES 390 C-Stahl M-Profil**

- Mit Innengewinde
- Material: E 195 - 1.0034
- Aussen galvanisch verzinkt
- O-Ring: EPDM schwarz

d mm	IG (Rp) Zoll	L mm	Z mm	Y mm	Orig. Nr.	📦 Stück	Art.-Nr.	CHF Stück
12	1/2	36	27	3	390102012	20	358101970	9.95
15	3/8	35	24	2	390308015	20	358101980	6.80
15	1/2	38	27	2	390102015	20	358101990	6.80
15	3/4	39	32	2	390304015	10	358102000	7.00
18	1/2	38	27	2	390102018	20	358102010	7.00
18	3/4	39	32	2	390304018	10	358102020	8.40
22	1/2	39	32	2	390102022	10	358102030	8.60
22	3/4	40	32	2	390304022	10	358102040	8.70
22	1	43	41	2	390100022	10	358102050	9.85
28	1/2	41	38	2	390102028	10	358102060	9.20
28	3/4	42	38	2	390304028	10	358102070	10.10
28	1	45	41	2	390100028	10	358102080	10.10
35	1	51	46	2	390100035	5	358102090	11.15
35	1 1/4	52	46	2	390114035	5	358102100	11.75
42	1 1/2	56	55	2	390112042	4	358102110	12.90
54	2	65	65	2	390200054	4	358102120	21.60
								3581

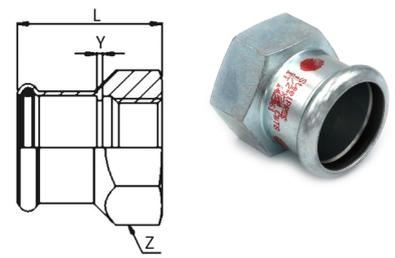
**Reduzierstücke STEELPRES 391 C-Stahl M-Profil**

- Material: E 195 - 1.0034
- Aussen galvanisch verzinkt
- O-Ring: EPDM schwarz

d mm	L mm	Z mm	Orig. Nr.	📦 Stück	Art.-Nr.	CHF Stück
15 x 12	51	33	391015012	20	358101540	3.45
18 x 12	53	35	391018012	20	358101550	3.45
18 x 15	57	37	391018015	20	358101560	3.55
22 x 12	60	42	391022012	20	358101570	3.75
22 x 15	64	44	391022015	20	358101580	3.55
22 x 18	60	40	391022018	20	358101590	3.85
28 x 15	76.5	56.5	391028015	20	358101600	6.00
28 x 18	68	48	391028018	20	358101610	5.60
28 x 22	65	42.5	391028022	20	358101620	3.50
35 x 22	70	49	391035022	10	358101630	4.80
35 x 28	71.0	48	391035028	10	358101640	4.10
42 x 22	97	76	391042022	4	358101650	16.50
42 x 28	93	70	391042028	4	358101660	16.50
42 x 35	81	55	391042035	4	358101670	14.20
54 x 22	104	83	391054022	4	358101680	29.35
54 x 28	108.5	85.5	391054028	4	358101690	29.35
54 x 35	108	82	391054035	4	358101700	25.75
54 x 42	97.5	67.5	391054042	4	358101710	16.05
						3581

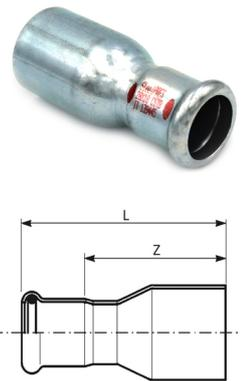
**Reduzierstücke STEELPRES 391 King Size C-Stahl M-Profil**

- Material: E 195 - 1.0034
- Aussen galvanisch verzinkt
- O-Ring: EPDM schwarz

d mm	L mm	Z mm	Orig. Nr.	📦 Stück	Art.-Nr.	CHF Stück
76.1 x 42	157	127	391076042	4	358200560	43.50
76.1 x 54	159	124	391076054	4	358200570	40.15
88.9 x 54	179	143	391088054	4	358200580	51.65
88.9 x 76.1	184	129	391088076	4	358200590	61.20
108 x 76.1	203	148	391108076	2	358200600	65.50
108 x 88.9	207	147	391108088	2	358200610	78.45
						3582

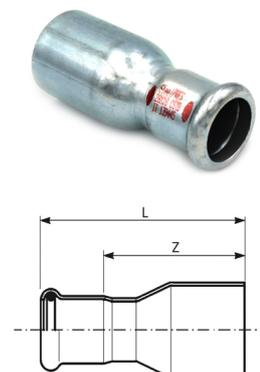



### Sprungbögen STEELPRES 379 C-Stahl M-Profil

- Material: E 195 - 1.0034
- Aussen galvanisch verzinkt

d mm	L mm	A mm	B mm	Orig. Nr.	Stück	Art.-Nr.	CHF Stück
12	55	154	35	379012000	10	358100180	4.80
15	57	158	30	379015000	10	358100190	5.15
18	60	166	31	379018000	10	358100200	5.70
22	65	179	33	379022000	10	358100210	6.85
28	73	206	36	379028000	10	358100220	8.15
							3581

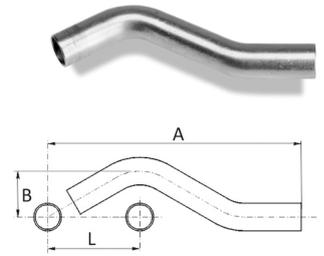

### Übergänge STEELPRES 393/M C-Stahl M-Profil

- Aussengewinde mit Einschubende
- Material: E 195 - 1.0034
- Aussen galvanisch verzinkt

d mm	AG (R) Zoll	L mm	Z mm	Y mm	Orig. Nr.	Stück	Art.-Nr.	CHF Stück
15	1/2	52	31	22	393102115	20	358102130	4.80
18	3/4	55	31	27	393304118	20	358102150	5.60
18	1/2	52	31	22	393102118	20	358102140	5.25
22	3/4	56	32	27	393304122	10	358102170	7.20
22	1/2	55	32	27	393102122	10	358102160	5.95
28	1	64	37	38	393100128	10	358102180	10.40
							3581	

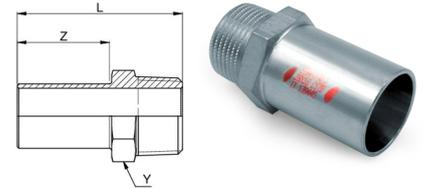

### Übergänge STEELPRES 393/F C-Stahl M-Profil

- Innengewinde mit Einschubende
- Material: E 195 - 1.0034
- Aussen galvanisch verzinkt

d mm	IG (Rp) Zoll	L mm	Z mm	Y mm	Orig. Nr.	Stück	Art.-Nr.	CHF Stück
15	1/2	52	37	24	393102015	20	358102190	4.40
18	1/2	52	37	24	393102018	20	358102200	4.75
18	3/4	51	37	30	393304018	20	358102210	5.30
22	1/2	52	37	24	393102022	20	358102220	5.90
22	3/4	52	38	30	393304022	20	358102230	6.85
							3581	

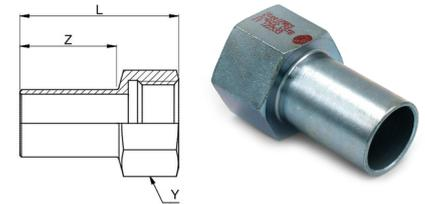

### Passbögen STEELPRES 394/900 C-Stahl M-Profil

- Material: E 195 - 1.0034
- Aussen galvanisch verzinkt

d mm	Winkel °	H1 mm	H min. mm	H2 mm	R mm	Orig. Nr.	Stück	Art.-Nr.	CHF Stück
15	90	70	48	120	35	394015900	20	358100450	4.35
18	90	70	53	120	38	394018900	20	358100460	4.85
22	90	70	61	120	40	394022900	10	358100470	4.95
28	90	97	80	125	45	394028900	10	358100480	5.65
35	90	120	90	200	42	394035900	4	358100490	12.90
42	90	160	115	250	50	394042900	2	358100500	19.90
54	90	300	140	305	65	394054900	2	358100510	27.10
							3581		

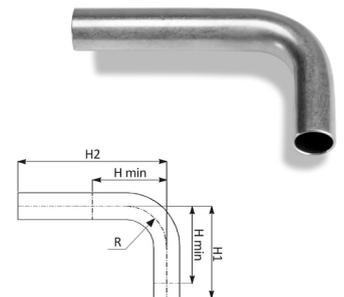

### Passbögen STEELPRES 394/300 C-Stahl M-Profil

- Material: E 195 - 1.0034
- Aussen galvanisch verzinkt

d mm	Winkel °	H1 mm	H min. mm	H2 mm	Orig. Nr.	Stück	Art.-Nr.	CHF Stück
28	30	54	47	130	394028300	10	358100270	9.20
35	30	80	50	218	394035300	4	358100280	17.40
42	30	98	54	274	394042300	2	358100290	25.60
54	30	137	72	324	394054300	2	358100300	33.55
							3581	

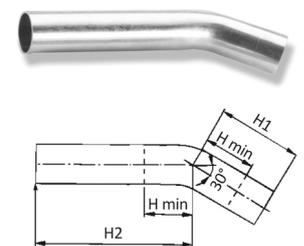

**Passbögen STEELPRES 394/150 C-Stahl M-Profil**

- Material: E 195 - 1.0034
- Aussen galvanisch verzinkt

d mm	Winkel °	H1 mm	H min. mm	H2 mm	Orig. Nr.	Stück	Art.-Nr.	CHF Stück
28	15	45	38	136	394028150	10	358100230	9.20
35	15	62	32	234	394035150	4	358100240	17.40
42	15	94	50	276	394042150	2	358100250	25.60
54	15	117	52	337	394054150	2	358100260	33.55
								3581

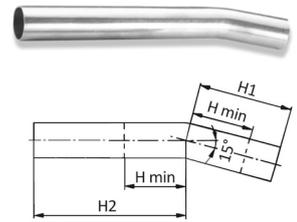

**Übergangsflansche STEELPRES 393/002 C-Stahl M-Profil**

- Material: E 195 - 1.0034
- Aussen galvanisch verzinkt
- O-Ring: EPDM schwarz
- PN 6

d mm	DN flg	H mm	Z mm	B mm	D mm	D2 mm	Lochanzahl Stück	K mm	PN bar	Orig. Nr.	Stück	Art.-Nr.	CHF Stück
15	15	39	19	12	80	11	4	55	6	393015002	2	358102540	31.90
18	15	39.5	19.5	12	80	11	4	55	6	393018002	2	358102550	33.60
22	20	42.5	21.5	14	90	11	4	65	6	393022002	2	358102560	36.20
28	25	45.5	22.5	14	100	11	4	75	6	393028002	2	358102570	42.70
35	32	51	25.5	16	120	14	4	90	6	393035002	2	358102580	49.15
42	40	55	25	16	130	14	4	100	6	393042002	2	358102590	54.35
54	50	62	26	16	140	14	4	110	6	393054002	2	358102600	66.00
													3581

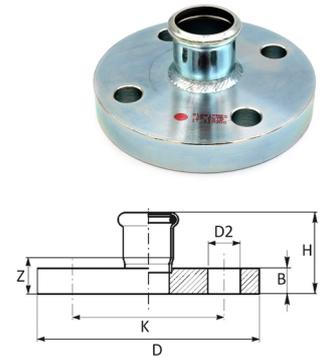

**Übergangsflansche STEELPRES 393/002 King Size C-Stahl M-Profil**

- Material: E 195 - 1.0034
- Aussen galvanisch verzinkt
- O-Ring: EPDM schwarz
- PN 6

d mm	DN flg	H mm	Z mm	B mm	D mm	D2 mm	Lochanzahl Stück	K mm	PN bar	Orig. Nr.	Stück	Art.-Nr.	CHF Stück
76.1	65	100.5	45.5	14	160	14	4	130	6	393076002	2	358200710	116.45
88.9	80	112	52	16	190	18	4	150	6	393088002	2	358200720	131.95
108	100	128	53	16	210	18	4	170	6	393108002	2	358200730	194.05
													3582

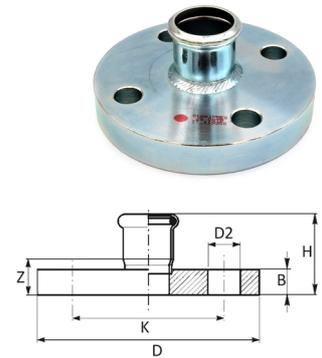

**Übergangsflansche STEELPRES 393/000 C-Stahl M-Profil**

- Material: E 195 - 1.0034
- Aussen galvanisch verzinkt
- O-Ring: EPDM schwarz
- PN 16

d mm	DN flg	H mm	Z mm	B mm	D mm	D2 mm	Lochanzahl Stück	K mm	PN bar	Orig. Nr.	Stück	Art.-Nr.	CHF Stück
15	15	43	23	16	95	14	4	65	16	393015000	2	358102610	38.95
18	15	44	24	16	95	14	4	65	16	393018000	2	358102620	40.40
22	20	47	26	18	105	14	4	75	16	393022000	2	358102630	43.90
28	25	50	27	18	115	14	4	85	16	393028000	2	358102640	48.60
35	32	53	27	18	140	18	4	100	16	393035000	2	358102650	60.80
42	40	57	27	18	150	18	4	110	16	393042000	2	358102660	68.90
54	50	64	28	18	165	18	4	125	16	393054000	2	358102670	85.35
													3581

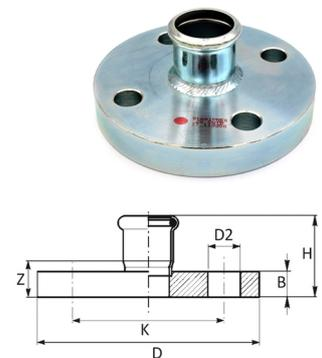



**Übergangsflansche STEELPRES 393/000 King Size C-Stahl M-Profil**

- Material: E 195 - 1.0034
- Aussen galvanisch verzinkt
- O-Ring: EPDM schwarz
- PN 16

d mm	DN flg	H mm	Z mm	B mm	D mm	D2 mm	Lochanzahl Stück	K mm	PN bar	Orig. Nr.	Art.-Nr.	CHF Stück
76.1	65	104.5	49.5	18	185	18	8	145	16	393076000	2 358200740	135.10
88.9	80	116	56	20	200	18	8	160	16	393088000	2 358200750	159.65
108	100	132	57	20	220	18	8	180	16	393108000	2 358200760	221.05
												3582

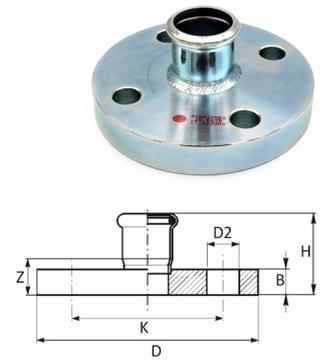

**Flanschdichtungen STEELPRES 434/PN 6**

- Material: Sesalit Eco
- PN 6

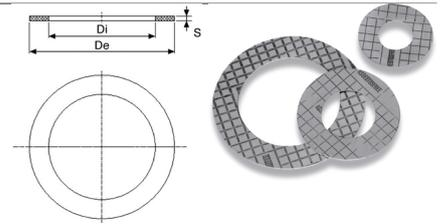
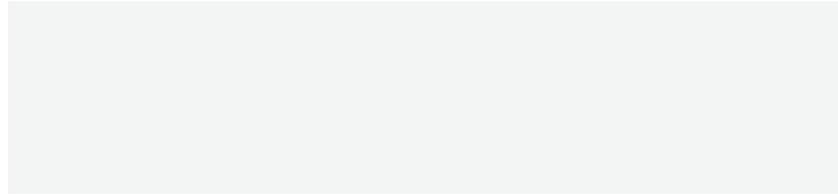

**Flanschdichtungen STEELPRES 434/PN 6 King Size**

- Material: Sesalit Eco
- PN 6

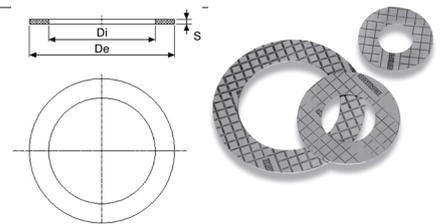
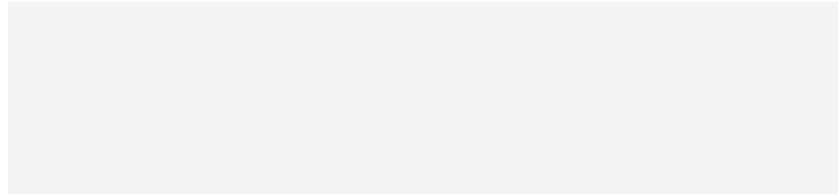

**Flanschdichtungen STEELPRES 434/PN10-16**

- Material: Sesalit Eco
- Norm: EN 1092-1
- PN 10/16

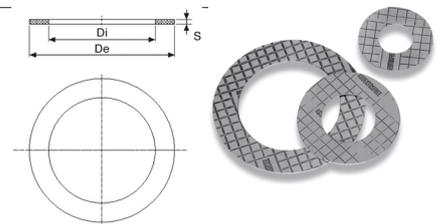

**Flanschdichtungen STEELPRES 434/PN10-16 King Size**

- Material: Sesalit Eco
- Norm: EN 1092-1
- PN 10/16

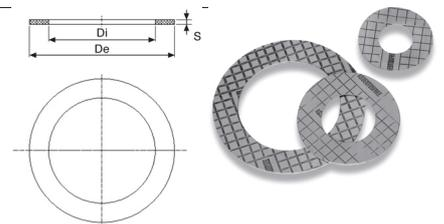

**Übergangskupplungen STEELPRES 322 C-Stahl M-Profil**

- Material: E 275+N - 1.0225

D mm	D1 mm	L mm	L1 mm	Orig. Nr.	Art.-Nr.	CHF Stück
60	42	120	69	322060042	1 358200680	42.10
60	54	120	80	322060054	1 358200690	37.30
76	54	130	76	322076054	1 358200700	54.55
						3582

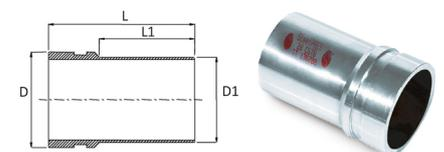

**Kombirohre STEELPRES 375 C-Stahl**

- Mit Anschweissenden
- Material: E 195 - 1.0034
- Nicht verzinkt

D mm	D1 mm	S1 mm	L1 mm	L mm	S mm	Orig. Nr.	Stück	Art.-Nr.	CHF Stück
17.2	12	1.5	26	120	4.10	375308012	10	358100100	26.35
17.2	15	1.5	30	120	2.60	375308015	10	358100110	27.80
21.3	18	1.5	30	120	3.15	375102018	10	358100120	29.35
26.9	22	1.5	34	120	3.95	375304022	10	358100130	32.05
33.7	28	1.5	34	120	4.35	375100028	5	358100140	40.50
42.4	35	1.5	40	120	5.20	375114035	5	358100150	48.55
48.3	42	1.5	45	120	4.65	375112042	5	358100160	57.30
60.3	54	1.5	50	120	4.65	375200054	2	358100170	93.95
									3581

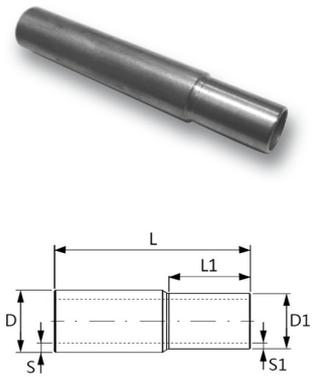

**Kombirohre STEELPRES 375 King Size C-Stahl**

- Mit Anschweissenden
- Material: E 195 - 1.0034
- Nicht verzinkt

D mm	D1 mm	S1 mm	L1 mm	L mm	S mm	Orig. Nr.	Stück	Art.-Nr.	CHF Stück
76.1	76.1	2	70	120	3.7	375212076	2	358200100	104.40
88.9	88.9	2	75	120	4.1	375300088	2	358200110	130.25
114.3	109	2	90	120	5.2	375400108	2	358200120	181.50
									3582

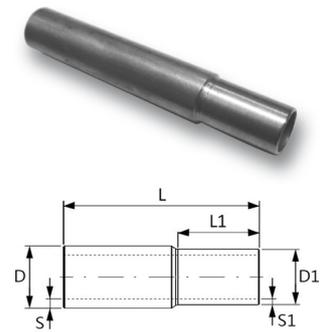

**Heizungsanschlüsse STEELPRES 396/RAD C-Stahl M-Profil**

- Material: E 195 - 1.0034
- O-Ring: EPDM schwarz

d mm	L mm	Z mm	Z1 mm	Z2 mm	Orig. Nr.	Stück	Art.-Nr.	CHF Stück	
15 x 1/2	80	16	131	81	396102015V	1	358102680	35.30	
18 x 1/2	80	16	131	81	396102018V	1	358102690	36.45	
									3581

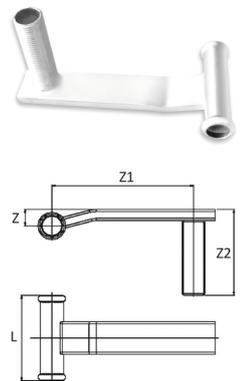

**Heizkörperanschlüsse STEELPRES 395 C-Stahl M-Profil**

- Material: E 195 - 1.0034
- Aussen galvanisch verzinkt
- O-Ring: EPDM schwarz

d1-d2 mm	A mm	B mm	C mm	D mm	Orig. Nr.	Stück	Art.-Nr.	CHF Stück	
12 x 12	30	40	60	100	395012012	1	358102700	58.85	
15 x 12	40	40	60	100	395015012	1	358102710	59.25	
15 x 15	40	40	60	100	395015015	1	358102720	59.45	
18 x 12	40	40	60	100	395018012	1	358102730	59.65	
18 x 15	40	40	60	100	395018015	1	358102740	61.10	
22 x 12	40	40	60	100	395022012	1	358102750	62.80	
22 x 15	40	40	60	100	395022015	1	358102760	65.70	
28 x 12	40	40	60	100	395028012	1	358102770	66.95	
28 x 15	40	40	60	100	395028015	1	358102780	67.80	
									3581

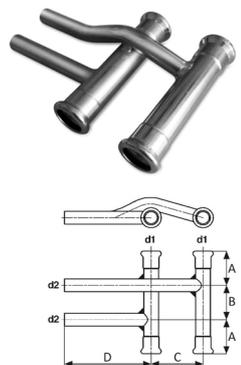

**Kreuzfittings STEELPRES 396 C-Stahl M-Profil**

- Material: E 195 - 1.0034
- Aussen galvanisch verzinkt
- O-Ring: EPDM schwarz

d1-d2 mm	A mm	B mm	C mm	D mm	Orig. Nr.	Stück	Art.-Nr.	CHF Stück
12 x 12	30	40	60	100	396012012	1	358102790	75.75
15 x 12	40	40	60	100	396015012	1	358102800	82.45
15 x 15	40	40	60	100	396015015	1	358102810	83.70
18 x 12	40	40	60	100	396018012	1	358102820	87.50
18 x 15	40	40	60	100	396018015	1	358102830	88.95
22 x 12	40	40	60	100	396022012	1	358102840	90.20
22 x 15	40	40	60	100	396022015	1	358102850	90.80
28 x 12	40	40	60	100	396028012	1	358102860	94.15
28 x 15	40	40	60	100	396028015	1	358102870	97.10
35 x 15	40	40	60	100	396035015	1	358102880	107.55
								3581

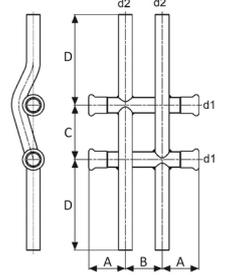



# 3

inoxPRES<sup>®</sup> 304L

Kälte  
inoxPRES



**Edelstahlrohre INOXPRES 114/200 Inox**

- Für Kälte-, Heizung- und Industrieanwendungen, **nicht geeignet für Trinkwasser**
- Material: AISI 304L - 1.4307
- Norm: EN 10217-7 (DIN 17455) - EN 10312

Abmessungen mm	Innen-Ø mm	Länge m	Volumen l / m	Orig. Nr.	☞ m	Art.-Nr.	CHF m
15 x 1	13	6	0.133	114015200	60	358500100	8.30
18 x 1	16	6	0.201	114018200	60	358500110	9.80
22 x 1.2	19.6	6	0.302	114022200	60	358500120	13.80
28 x 1.2	25.6	6	0.514	114028200	30	358500130	17.75
35 x 1.5	32	6	0.804	114035200	30	358500140	26.80
42 x 1.5	39	6	1.194	114042200	30	358500150	33.00
54 x 1.5	51	6	2.042	114054200	30	358500160	43.70
							3585

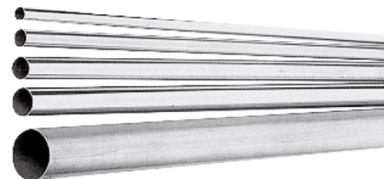
**Edelstahlrohre INOXPRES 114/200 King Size Inox**

- Für Kälte-, Heizung- und Industrieanwendungen, **nicht geeignet für Trinkwasser**
- Material: AISI 304L - 1.4307
- Norm: EN 10217-7 (DIN 17455) - EN 10312

Abmessungen mm	Innen-Ø mm	Länge m	Volumen l / m	Orig. Nr.	☞ m	Art.-Nr.	CHF m
76.1 x 2	72.1	6	4.080	114076200	6	358600100	82.55
88.9 x 2	84.9	6	5.660	114088200	6	358600110	87.05
108 x 2	104	6	8.490	114108200	6	358600120	94.00
							3586

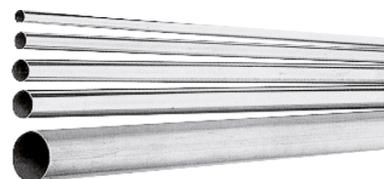
**Bögen INOXPRES Uniko 304L 181/450 UNW Inox M/V-Profil**

- Material: AISI 304L - 1.4307
- O-Ring: EPDM schwarz l/l

d mm	Winkel °	L mm	Z mm	Orig. Nr.	☞ Stück	☞ Stück	Art.-Nr.	CHF Stück
15	45	29.5	7.5	181015450CUNW	20	300	359800010	0.00
18	45	31.5	9.5	181018450CUNW	20	300	359800020	0.00
22	45	34	10	181022450CUNW	20	100	359800030	0.00
28	45	39	15	181028450CUNW	10	100	359800040	0.00
35	45	47.5	19.5	181035450UNW	10	60	359800050	0.00
42	45	59	23	181042450UNW	4	32	359800060	0.00
54	45	69	28	181054450UNW	2	20	359800070	0.00
								3598

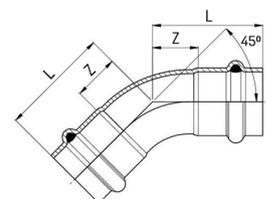
**Bögen INOXPRES 181/450 NW King Size Inox M-Profil**

- Material: AISI 304L - 1.4307
- O-Ring: EPDM schwarz l/l

De mm	Winkel °	L mm	Z mm	Orig. Nr.	☞ Stück	Art.-Nr.	CHF Stück
76.1	45	98	43	181076450NW	2	358800100	110.50
88.9	45	112	52	181088450NW	2	358800110	132.00
108	45	138	63	181108450NW	2	358800120	180.00
							3588

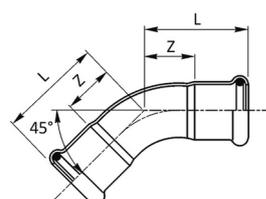



**Bögen INOXPRES Uniko 304L 181/451 UNW Inox M/V-Profil**

- Material: AISI 304L - 1.4307
- O-Ring: EPDM schwarz I/A

d mm	Winkel °	L mm	H mm	Z mm	Orig. Nr.	Stück	Stück	Art.-Nr.	CHF Stück
15	45	29.5	36.5	7.5	181015451CUNW	20	300	359800080	0.00
18	45	31.5	38	9.5	181018451CUNW	20	300	359800090	0.00
22	45	34	42	10	181022451CUNW	20	100	359800100	0.00
28	45	39	45	15	181028451CUNW	10	100	359800110	0.00
35	45	47.5	57.5	19.5	181035451UNW	10	60	359800120	0.00
42	45	59	72	23	181042451UNW	4	40	359800130	0.00
54	45	69	78	28	181054451UNW	2	20	359800140	0.00
									3598

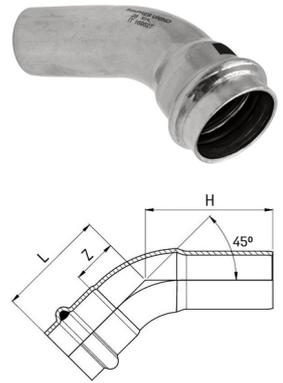

**Bögen INOXPRES 181/451 NW King Size Inox M-Profil**

- Material: AISI 304L - 1.4307
- O-Ring: EPDM schwarz I/A

De mm	Winkel °	L mm	H mm	Z mm	Orig. Nr.	Stück	Art.-Nr.	CHF Stück
76.1	45	98	117	43	181076451NW	2	358800130	101.50
88.9	45	112	131	52	181088451NW	2	358800140	121.00
108	45	138	154	63	181108451NW	2	358800150	165.50
								3588

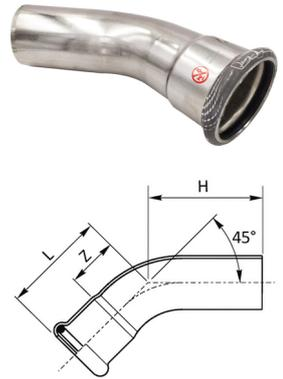

**Bögen INOXPRES Uniko 304L 181/900 UNW Inox M/V-Profil**

- Material: AISI 304L - 1.4307
- O-Ring: EPDM schwarz I/I

d mm	Winkel °	L mm	Z mm	Orig. Nr.	Stück	Stück	Art.-Nr.	CHF Stück	
15	90	40	18	181015900CUNW	20	300	359800150	0.00	
18	90	42	20	181018900CUNW	20	200	359800160	0.00	
22	90	49	25	181022900CUNW	10	100	359800170	0.00	
28	90	58	34	181028900CUNW	10	50	359800180	0.00	
35	90	72	44	181035900UNW	5	50	359800190	0.00	
42	90	88	52	181042900UNW	2	30	359800200	0.00	
54	90	107	66	181054900UNW	2	16	359800210	0.00	
									3598

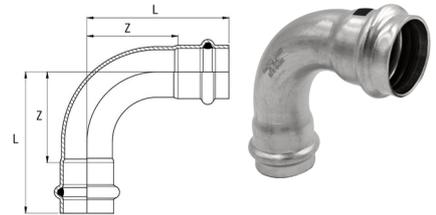

**Bögen INOXPRES 181/900 NW King Size Inox M-Profil**

- Material: AISI 304L - 1.4307
- O-Ring: EPDM schwarz I/I

De mm	Winkel °	L mm	Z mm	Orig. Nr.	Stück	Art.-Nr.	CHF Stück
76.1	90	150	95	181076900NW	2	358800160	112.50
88.9	90	174	114	181088900NW	2	358800170	137.00
108	90	215	140	181108900NW	2	358800180	186.50
							3588

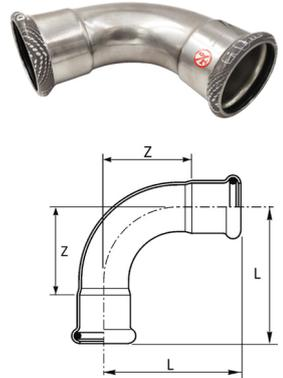

INOXPRES UNIKO 304L

**Bögen INOXPRES Uniko 304L 181/901 UNW Inox M/V-Profil**

- Material: AISI 304L - 1.4307
- O-Ring: EPDM schwarz I/A

d mm	Winkel °	L mm	H mm	Z mm	Orig. Nr.	Stück	Stück	Art.-Nr.	CHF Stück
15	90	40	47	18	181015901CUNW	20	300	359800220	0.00
18	90	42	50	20	181018901CUNW	20	200	359800230	0.00
22	90	9	57	5	181022901CUNW	10	100	359800240	0.00
28	90	58	64	34	181028901CUNW	10	50	359800250	0.00
35	90	72	82	44	181035901UNW	5	50	359800260	0.00
42	90	88	100	52	181042901UNW	2	30	359800270	0.00
54	90	107	120	66	181054901UNW	2	16	359800280	0.00
									3598

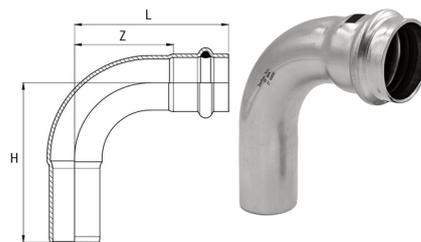

INOXPRES 304L

**Bögen INOXPRES 181/901 NW King Size Inox M-Profil**

- Material: AISI 304L - 1.4307
- O-Ring: EPDM schwarz I/A

De mm	Winkel °	L mm	H mm	Z mm	Orig. Nr.	Stück	Art.-Nr.	CHF Stück
76.1	90	150	165	95	181076901NW	2	358800190	116.00
88.9	90	174	190	114	181088901NW	2	358800200	141.00
108	90	215	238	140	181108901NW	2	358800210	192.00
								3588

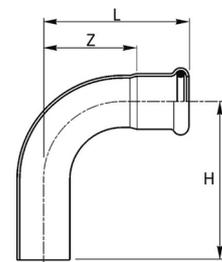

INOXPRES UNIKO 304L

**Bögen INOXPRES Uniko 304L 186/M UNW Inox M/V-Profil**

- Mit Aussengewinde
- Material: AISI 304L - 1.4307
- Gewinde: EN10226-1 (ex ISO 7/1)
- O-Ring: EPDM schwarz

d mm	AG (R) Zoll	Winkel °	L mm	H mm	Z mm	Z1 mm	Orig. Nr.	Stück	Stück	Art.-Nr.	CHF Stück
15	1/2	90	39	39	22	17	186102015CUNW	20	300	359800360	0.00
18	1/2	90	42	42	24	20	186102018CUNW	20	200	359800370	0.00
22	3/4	90	47	49	28	24	186304022CUNW	10	100	359800380	0.00
28	1	90	54	63	36	30	186100028CUNW	10	50	359800390	0.00
											3598

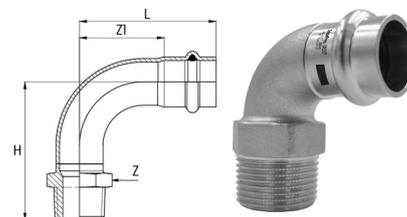

INOXPRES UNIKO 304L

**Sprungbögen INOXPRES Uniko 304L 179 NW Inox M/V-Profil**

- Material: AISI 316L - 1.4404

d mm	L mm	A mm	B mm	Orig. Nr.	Stück	Stück	Art.-Nr.	CHF Stück
15	57	158	30	179015000NW	10	150	359801900	0.00
18	60	158	31	179018000NW	10	100	359801910	0.00
								3598

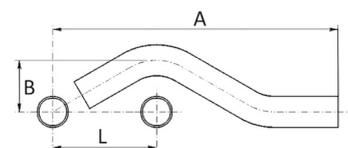

INOXPRES UNIKO 304L



**T-Stücke INOXPRES Uniko 304L 182 UNW Inox M/V-Profil**

- Material: AISI 304L - 1.4307
- O-Ring: EPDM schwarz

d mm	L1 mm	L2 mm	Z1 mm	Z2 mm	Orig. Nr.	📦 Stück	📦 Stück	Art.-Nr.	CHF Stück
15	43	41	21	19	182015000UNW	20	200	359800400	0.00
18	45	43	23	21	182018000UNW	20	100	359800410	0.00
22	49	47.5	25	23.5	182022000UNW	10	80	359800420	0.00
28	52	51.5	28	27.5	182028000UNW	10	50	359800430	0.00
35	62	58.5	34	30.5	182035000UNW	4	32	359800440	0.00
42	75	70.5	39	34.5	182042000UNW	4	20	359800450	0.00
54	89	83.5	48	42.5	182054000UNW	2	12	359800460	0.00
									3598

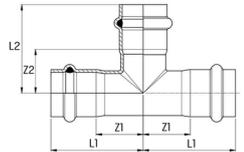

INOXPRES 304L



**T-Stücke INOXPRES 182 NW King Size Inox M-Profil**

- Material: AISI 304L - 1.4307
- O-Ring: EPDM schwarz

De mm	L1 mm	L2 mm	Z1 mm	Z2 mm	Orig. Nr.	📦 Stück	Art.-Nr.	CHF Stück
76.1	108	118	53	63	182076000NW	2	358800220	232.50
88.9	132	131	72	71	182088000NW	2	358800230	254.50
108	155	159	74	84	182108000NW	2	358800240	313.50
								3588

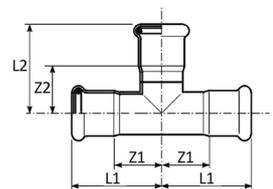

INOXPRES UNIKO 304L



**T-Stücke INOXPRES Uniko 304L 189 UNW Inox M/V-Profil**

- Mit Abgang Innengewinde
- Material: AISI 304L - 1.4307
- O-Ring: EPDM schwarz

d mm	IG (Rp) Zoll	L1 mm	L2 mm	Z1 mm	Z2 mm	Orig. Nr.	📦 Stück	📦 Stück	Art.-Nr.	CHF Stück
15	1/2	38.5	22.5	16.5	8.5	189102015UNW	20	100	359800470	0.00
18	1/2	38	24	16	10	189102018UNW	20	100	359800480	0.00
22	1/2	41	26	18	12	189102022UNW	10	100	359800490	0.00
22	3/4	43.5	30	20.5	14	189304022UNW	10	100	359800500	0.00
28	1/2	42	29	18	15	189102028UNW	10	50	359800510	0.00
28	3/4	45	30	21	14	189304028UNW	10	50	359800520	0.00
28	1	45	34	21	16	189100028UNW	5	50	359800530	0.00
35	1/2	62	50	34	35	189102035UNW	5	50	359800540	0.00
42	1/2	75	53.5	39	38.5	189102042UNW	4	20	359800550	0.00
54	1/2	89	61	48	46	189102054UNW	2	14	359800560	0.00
									3598	

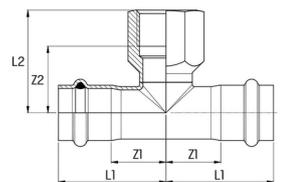

INOXPRES 304L



**T-Stücke INOXPRES 189 NW King Size Inox M-Profil**

- Mit Abgang und Innengewinde
- Material: AISI 304L - 1.4307
- Gewindenorm: EN 10226-1 (ex ISO 7/1)
- O-Ring: EPDM schwarz

De mm	IG (Rp) Zoll	L1 mm	L2 mm	Z1 mm	Z2 mm	Orig. Nr.	📦 Stück	Art.-Nr.	CHF Stück
76.1	3/4	108	77	53	60	189304076NW	2	358800280	203.50
76.1	2	108	93	53	67	189200076NW	2	358800290	222.50
88.9	3/4	132	84	72	67	189304088NW	2	358800300	219.50
88.9	2	132	100	72	74	189200088NW	2	358800310	231.00
108	3/4	155	94	74	77	189304108NW	2	358800320	269.00
108	2	155	110	74	84	189200108NW	2	358800330	285.00
									3588

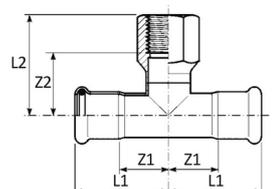

INOXPRES 304L

**T-Stücke INOXPRES Uniko 304L 192 UNW Inox M/V-Profil**

- Mit reduziertem Abgang
- Material: AISI 304L - 1.4307
- O-Ring: EPDM schwarz

d mm	L1 mm	L2 mm	Z1 mm	Z2 mm	Orig. Nr.	☞ Stück	☞ Stück	Art.-Nr.	CHF Stück
18 x 15 x 18	45	42.5	23	20.5	192018015UNW	20	100	359800570	0.00
22 x 15 x 22	49	45	25	23	192022015UNW	10	100	359800580	0.00
22 x 18 x 22	9	45.5	25	23.5	192022018UNW	10	100	359800590	0.00
28 x 15 x 28	52	47.5	28	25.5	192028015UNW	10	50	359800600	0.00
28 x 18 x 28	52	48	28	26	192028018UNW	10	50	359800610	0.00
35 x 15 x 35	62	51	34	29	192028022UNW	10	50	359800620	0.00
28 x 22 x 28	52	50	28	26	192035015UNW	5	35	359800630	0.00
35 x 18 x 35	62	51.5	34	29.5	192035018UNW	5	35	359800640	0.00
35 x 22 x 35	62	53.5	34	29.5	192035022UNW	5	35	359800650	0.00
35 x 28 x 35	62	55	34	31	192035028UNW	5	35	359800660	0.00
42 x 18 x 42	75	55	39	33	192042018UNW	4	20	359800670	0.00
42 x 22 x 42	75	57	39	33	192042022UNW	4	20	359800680	0.00
42 x 28 x 42	75	58.5	39	34.5	192042028UNW	4	20	359800690	0.00
42 x 35 x 42	75	61	39	33	192042035UNW	4	20	359800700	0.00
54 x 22 x 54	89	64.5	48	40.5	192054022UNW	2	16	359800710	0.00
54 x 28 x 54	89	66	48	42	192054028UNW	2	16	359800720	0.00
54 x 35 x 54	89	68.5	48	40.5	192054035UNW	2	16	359800730	0.00
54 x 42 x 54	89	78	48	42	192054042UNW	2	16	359800740	0.00
									3598

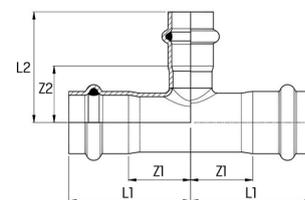

INOXPRES 304L

**T-Stücke INOXPRES 192 NW King Size Inox M-Profil**

- Mit reduziertem Abgang
- Material: AISI 304L - 1.4307
- O-Ring: EPDM schwarz

De mm	L1 mm	L2 mm	Z1 mm	Z2 mm	Orig. Nr.	☞ Stück	Art.-Nr.	CHF Stück
88.9 x 76.1 x 88.9	132	125	72	70	192088076NW	2	358800250	265.00
108 x 76.1 x 108	155	135	74	80	192108076NW	2	358800260	283.50
108 x 88.9 x 108	155	141	74	81	192108088NW	2	358800270	327.50
								3588

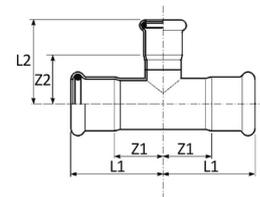

INOXPRES 304L

**T-Stücke INOXPRES Uniko 304L 192/L UNW Inox M/V-Profil**

- Mit reduziertem Abgang
- Material: AISI 304L - 1.4307
- O-Ring: EPDM schwarz

d mm	L1 mm	L2 mm	L3 mm	Z1 mm	Z2 mm	Z3 mm	Orig. Nr.	☞ Stück	☞ Stück	Art.-Nr.	CHF Stück
18 x 15 x 15	43	43	41	21	21	19	192181515UNW	20	100	359800750	0.00
											3598

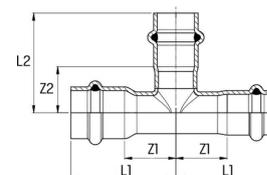



### Muffen INOXPRES Uniko 304L 183/000 UNW Inox M/V-Profil

- Material: AISI 304L - 1.4307
- O-Ring: EPDM schwarz

d mm	L mm	Z mm	Orig. Nr.	☞ Stück	☞ Stück	Art.-Nr.	CHF Stück
15	57	13	183015000UNW	20	400	359800760	0.00
18	57	13	183018000UNW	20	300	359800770	0.00
22	59	11	183022000UNW	20	200	359800780	0.00
28	61	13	183028000UNW	10	150	359800790	0.00
35	70	14	183035000UNW	10	80	359800800	0.00
42	84	12	183042000UNW	4	40	359800810	0.00
54	92	10	183054000UNW	2	24	359800820	0.00
							3598

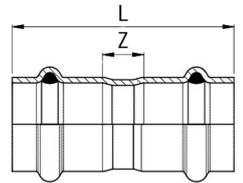

### Muffen INOXPRES 183/000 NW King Size Inox M-Profil

- Material: AISI 304L - 1.4307
- O-Ring: EPDM schwarz

De mm	L mm	Z mm	Orig. Nr.	☞ Stück	Art.-Nr.	CHF Stück
76.1	142	32	183076000NW	4	358800340	71.00
88.9	166	46	183088000NW	4	358800350	81.50
108	203	41	183108000NW	2	358800360	103.50
						3588

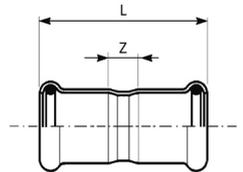

### Schiebemuffen INOXPRES Uniko 304L 183/001 UNW Inox M/V-Profil

- Material: AISI 304L - 1.4307
- O-Ring: EPDM schwarz

d mm	L mm	es mm	Orig. Nr.	☞ Stück	☞ Stück	Art.-Nr.	CHF Stück
15	82	25	183015001UNW	20	200	359800830	0.00
18	86	25	183018001UNW	20	200	359800840	0.00
22	92	25	183022001UNW	20	100	359800850	0.00
28	101	30	183028001UNW	10	80	359800860	0.00
35	119	30	183035001UNW	5	50	359800870	0.00
42	135	40	183042001UNW	4	40	359800880	0.00
54	158	45	183054001UNW	2	20	359800890	0.00
							3598

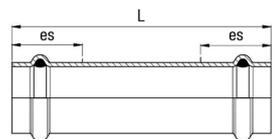

### Schiebemuffen INOXPRES 183/001 NW King Size Inox M-Profil

- Material: AISI 304L - 1.4307
- O-Ring: EPDM schwarz

De mm	L mm	es mm	Orig. Nr.	☞ Stück	Art.-Nr.	CHF Stück
76.1	230	60	183076001NW	2	358800370	214.00
88.9	260	70	183088001NW	2	358800380	243.00
108	310	80	183108001NW	2	358800390	300.50
						3588

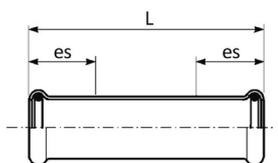

INOXPRES 304L



### Reduzierstücke INOXPRES Uniko 304L 191 UNW Inox M/V-Profil

- Material: AISI 316L - 1.4404
- O-Ring: EPDM schwarz

d mm	L mm	Z mm	Orig. Nr.	Stück	Stück	Art.-Nr.	CHF Stück
18 x 15	62.5	40.5	191018015UNW	20	300	359801690	0.00
22 x 15	78	56	191022015UNW	20	300	359801700	0.00
22 x 18	68.5	46.5	191022018UNW	20	300	359801710	0.00
28 x 15	78.5	56.5	191028015UNW	20	200	359801720	0.00
28 x 18	75	53	191028018UNW	20	200	359801730	0.00
28 x 22	71.5	47.5	191028022UNW	20	200	359801740	0.00
35 x 15	89	67	191035015UNW	10	100	359801750	0.00
35 x 18	89	67	191035018UNW	10	100	359801760	0.00
35 x 22	85.5	61.5	191035022UNW	10	100	359801770	0.00
35 x 28	79.5	55.5	191035028UNW	10	80	359801780	0.00
42 x 22	109.5	85.5	191042022UNW	4	80	359801790	0.00
42 x 28	103	79	191042028UNW	4	80	359801800	0.00
42 x 35	95	67	191042035UNW	4	40	359801810	0.00
54 x 28	110	86	191054028UNW	4	40	359801820	0.00
54 x 35	113.5	85.5	191054035UNW	4	40	359801830	0.00
54 x 42	111	75	191054042UNW	4	32	359801840	0.00
							3598

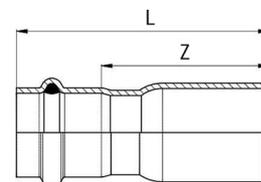

INOXPRES 304L



### Reduzierstücke INOXPRES 191 NW King Size Inox M-Profil

- Material: AISI 304L - 1.4307
- O-Ring: EPDM schwarz

De mm	L mm	Z mm	Orig. Nr.	Stück	Art.-Nr.	CHF Stück
88.9 x 76.1	186	131	191088076NW	4	358800400	100.00
108 x 76.1	209	154	191108076NW	2	358800410	103.00
108 x 88.9	210	150	191108088NW	2	358800420	114.50
						3588

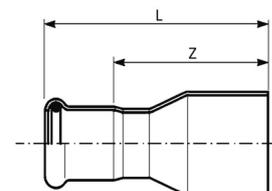

INOXPRES 304L



### Verschlusskappen INOXPRES Uniko 304L 183/003 UNW Inox M/V-Profil

- Material: AISI 316L - 1.4404
- O-Ring: EPDM schwarz

d mm	L1 mm	L mm	Orig. Nr.	Stück	Stück	Art.-Nr.	CHF Stück
15	28	6	183015003UNW	20	500	359800980	0.00
18	28	6	183018003UNW	20	300	359800990	0.00
22	29	6	183022003UNW	10	200	359801000	0.00
28	30	6	183028003UNW	10	150	359801010	0.00
35	52.5	26.5	183035003UNW	5	100	359801020	0.00
42	62	26	183042003UNW	4	80	359801030	0.00
54	67.5	26.5	183054003UNW	4	40	359801040	0.00
							3598

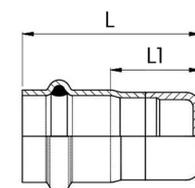

INOXPRES 304L



### Verschlusskappen INOXPRES 183/003 NW King Size Inox M-Profil

- Material: AISI 304L - 1.4307
- O-Ring: EPDM schwarz

De mm	L mm	L1 mm	Orig. Nr.	Stück	Art.-Nr.	CHF Stück
76.1	93	38	183076003NW	10	358800430	46.50
88.9	99	39	183088003NW	10	358800440	57.50
108	117	42	183108003NW	2	358800450	71.00
						3588

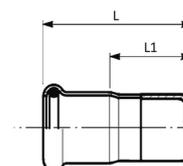



**Anschlussverschraubungen INOXPRES Uniko 304L 183/002 UNW Inox M/V-Profil**

- Material: AISI 316L - 1.4404
- O-Ring / Dichtung: EPDM schwarz

d	IG (G)	L	Z	Y	Dichtung	Orig. Nr.	☞	☞	Art.-Nr.	CHF
mm	Zoll	mm	mm	mm			Stück	Stück		Stück
15	3/4	51.5	30	23	24x14 thk 2.5	183015002UNW	10	250	359800900	0.00
18	1/2	50	27	22.5	18x10 thk 2.5	183018012UNW	10	250	359800910	0.00
18	3/4	52	30	23.5	24x14 thk 2.5	183018002UNW	10	250	359800920	0.00
22	3/4	52.5	30	22	24x14 thk 2.5	183022012UNW	10	200	359800930	0.00
22	1	54.5	36	23.5	30x20 thk 2.5	183022002UNW	10	200	359800940	0.00
28	1	53.5	36	22.5	30x20 thk 2.5	183028012UNW	10	150	359800950	0.00
28	1 1/4	57.5	46	25	39x27 thk 2.5	183028002UNW	10	120	359800960	0.00
35	1 1/2	63	52	27	44.5x34 thk 2.5	183035002UNW	4	60	359800970	0.00
										3598

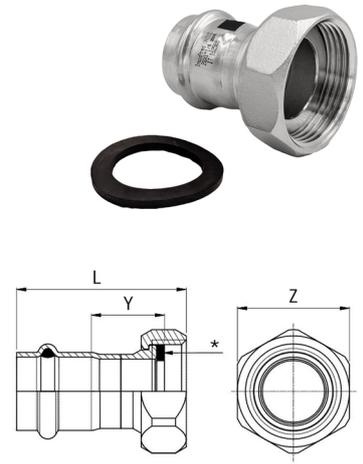

**Durchgangverschraubungen INOXPRES Uniko 304L 184/001 UNW Inox M/V-Profil**

- Mit Pressenden flachdichtend
- Material: AISI 316L - 1.4404
- O-Ring / Dichtung: EPDM schwarz

d	Y	L	Z	Orig. Nr.	☞	☞	Art.-Nr.	CHF	
mm	mm	mm	mm		Stück	Stück		Stück	
15	56	100	34	184015001UNW	10	100	359801480	0.00	
18	57	101	39	184018001UNW	10	100	359801490	0.00	
22	57	105	39	184022001UNW	10	80	359801500	0.00	
28	72	120	58	184028001UNW	5	30	359801510	0.00	
35	71.5	127.5	67	184035001UNW	4	20	359801520	0.00	
42	80	152	77	184042001UNW	2	20	359801530	0.00	
54	83.5	165.5	90	184054001UNW	2	10	359801540	0.00	
									3598

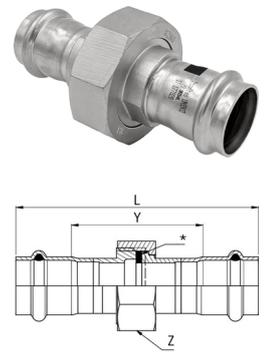

**Durchgangverschraubungen INOXPRES Uniko 304L 184/002 UNW Inox M/V-Profil**

- Mit Aussengewinde, Anschlussmuffe Messing
- Material: AISI 316L - 1.4404
- Gewindenorm: EN 10226-1 (ex ISO 7/1)
- O-Ring / Dichtung: EPDM schwarz

d	AG (R)	L	Z	Dichtung	Orig. Nr.	☞	☞	Art.-Nr.	CHF	
mm	Zoll	mm	mm			Stück	Stück		Stück	
15	1/2	78.5	56.5	24x14 thk 2.5	184015002UNW	2	120	359801550	0.00	
18	1/2	79	57	24x14 thk 2.5	184018002UNW	2	120	359801560	0.00	
22	3/4	83.5	59.5	30x20 thk 2.5	184022002UNW	2	80	359801570	0.00	
28	1	91.5	67.5	39x27 thk 2.5	184028002UNW	2	50	359801580	0.00	
35	1 1/4	101	73	44.5x34 thk 2.5	184035002UNW	2	30	359801590	0.00	
42	1 1/2	110.5	74.5	50.5x40 thk 2.5	184042002UNW	2	30	359801600	0.00	
54	2	123	82	65.5x53.5 thk 2.5	184054002UNW	2	16	359801610	0.00	
										3598

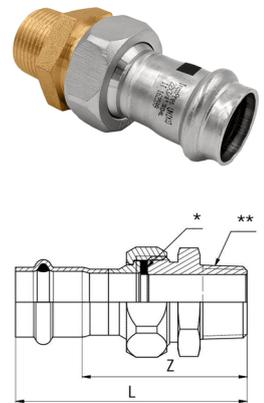

**Durchgangverschraubungen INOXPRES Uniko 304L 184/003 UNW Inox M/V-Profil**

- Mit Innengewinde, Anschlussmuffe Messing
- Material: AISI 316L - 1.4404
- Gewindenorm: EN 10226-1 (ex ISO 7/1)
- O-Ring / Dichtung: EPDM schwarz

d	IG (Rp)	L	Z	Dichtung	Orig. Nr.	☞	☞	Art.-Nr.	CHF	
mm	Zoll	mm	mm			Stück	Stück		Stück	
15	1/2	73	51	24x14 thk 2.5	184015003UNW	2	120	359801620	0.00	
18	1/2	73.5	51.5	24x14 thk 2.5	184018003UNW	2	120	359801630	0.00	
22	3/4	78.5	54.5	30x20 thk 2.5	184022003UNW	2	80	359801640	0.00	
28	1	84	60	39x27 thk 2.5	184028003UNW	2	40	359801650	0.00	
35	1 1/4	93	65	44.5x34 thk 2.5	184035003UNW	2	30	359801660	0.00	
42	1 1/2	102.5	66.5	50.5x40 thk 2.5	184042003UNW	2	30	359801670	0.00	
54	2	121	80	65.5x53.5 thk 2.5	184054003UNW	2	16	359801680	0.00	
										3598

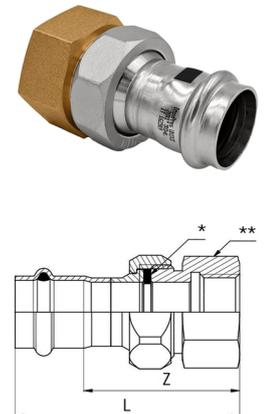

### Übergangsstücke INOXPRES Uniko 304L 187 UNW Inox M/V-Profil

- Mit Aussengewinde
- Material: AISI 316L - 1.4404
- Gewindenorm: EN 10226-1 (ex ISO 7/1)
- O-Ring: EPDM schwarz

d mm	AG (R) Zoll	L mm	Z mm	Y mm	Orig. Nr.	☞ Stück	☞ Stück	Art.-Nr.	CHF Stück
15	1/2	42	24	21	187102015UNW	20	300	359801050	0.00
15	3/4	45	30	24	187304015UNW	20	200	359801060	0.00
18	1/2	42	27	21	187102018UNW	20	300	359801070	0.00
18	3/4	45	30	24	187304018UNW	20	200	359801080	0.00
22	1/2	46	32	24	187102022UNW	10	200	359801090	0.00
22	3/4	46	32	24	187304022UNW	10	200	359801100	0.00
22	1	49	36	27	187100022UNW	10	100	359801110	0.00
28	3/4	48	38	25	187304028UNW	10	100	359801120	0.00
28	1	50	38	27	187100028UNW	10	100	359801130	0.00
28	1 1/4	54	46	31	187114028UNW	10	60	359801140	0.00
35	1	54	45	27	187100035UNW	5	100	359801150	0.00
35	1 1/4	58	46	31	187114035UNW	5	50	359801160	0.00
35	1 1/2	58	50	31	187112035UNW	4	60	359801170	0.00
42	1 1/4	65	54	31	187114042UNW	4	40	359801180	0.00
42	1 1/2	65	54	31	187112042UNW	4	40	359801190	0.00
54	1 1/2	73	67	34	187112054UNW	4	32	359801200	0.00
54	2	78	67	39	187200054UNW	4	32	359801210	0.00
									3598

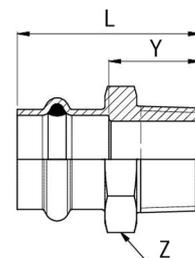

### Übergangsstücke INOXPRES 187 NW King Size Inox M-Profil

- Mit Aussengewinde
- Material: AISI 304L - 1.4307
- Gewinde: EN10226-1 (ex ISO 7/1)
- O-Ring: EPDM schwarz

De mm	AG (R) Zoll	L mm	Z mm	Y mm	Orig. Nr.	☞ Stück	Art.-Nr.	CHF Stück
76.1	2 1/2	98	83	43	187212076NW	8	358800460	232.00
88.9	3	111	98	51	187300088NW	4	358800470	346.50
108	4	132	118	57	187400108NW	2	358800480	399.00
								3588

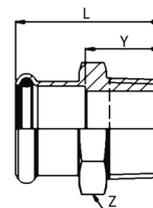

### Übergangsstücke INOXPRES Uniko 304L 190 UNW Inox M/V-Profil

- Mit Innengewinde
- Material: AISI 316L - 1.4404
- Gewinde: ISO 7/1 - ANSI B 1.20.1
- O-Ring: EPDM schwarz

d mm	IG (Rp) Zoll	L mm	Z mm	Y mm	Orig. Nr.	☞ Stück	☞ Stück	Art.-Nr.	CHF Stück
15	1/2	40	27	2	190102015UNW	20	240	359801220	0.00
15	3/4	41	32	2	190304015UNW	20	240	359801230	0.00
18	1/2	40	27	2	190102018UNW	20	240	359801240	0.00
18	3/4	41	32	2	190304018UNW	10	200	359801250	0.00
22	1/2	40	32	2	190102022UNW	20	200	359801260	0.00
22	3/4	42	32	2	190304022UNW	10	150	359801270	0.00
22	1	46	41	2	190100022UNW	10	100	359801280	0.00
28	3/4	42	38	2	190304028UNW	10	100	359801290	0.00
28	1	47	41	2	190100028UNW	10	100	359801300	0.00
28	1 1/4	49	46	2	190114028UNW	10	100	359801310	0.00
35	1	51	46	2	190100035UNW	5	80	359801320	0.00
35	1 1/4	54	46	2	190114035UNW	5	50	359801330	0.00
42	1 1/4	60	55	2	190114042UNW	4	40	359801340	0.00
42	1 1/2	60	55	2	190112042UNW	4	40	359801350	0.00
54	1 1/2	63	67	1	190112054UNW	4	32	359801360	0.00
54	2	70	67	2	190200054UNW	4	20	359801370	0.00
									3598

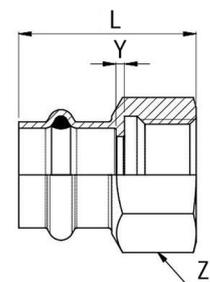



**Übergangswinkel INOXPRES Uniko 304L 197 UNW Inox M/V-Profil**

- Mit Aussengewinde
- Material: AISI 304L - 1.4307
- Gewinde: EN10226-1 (ex ISO 7/1)
- O-Ring: EPDM schwarz

d mm	AG (R) Zoll	Winkel °	L1 mm	L2 mm	Z mm	Y mm	Orig. Nr.	Stück	Stück	Art.-Nr.	CHF Stück
15	1/2	90	44.5	42	20	22	197102015UNW	10	150	359800290	0.00
18	1/2	90	44.5	42	20	22	197102018UNW	10	150	359800300	0.00
											3598

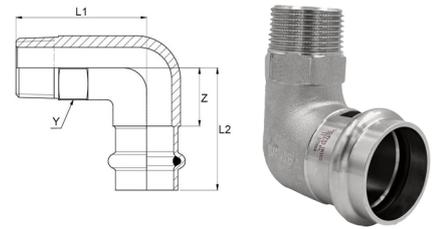

**Übergangswinkel INOXPRES Uniko 304L 198 UNW Inox M/V-Profil**

- Mit Innengewinde
- Material: AISI 304L - 1.4307
- Gewinde: EN10226-1 (ex ISO 7/1)
- O-Ring: EPDM schwarz

d mm	IG (Rp) Zoll	Winkel °	L1 mm	L2 mm	Z1 mm	Z2 mm	Y mm	Orig. Nr.	Stück	Stück	Art.-Nr.	CHF Stück
15	1/2	90	33	44	15	22	27	198102015UNW	10	150	359800310	0.00
18	1/2	90	33	44	15	22	27	198102018UNW	10	150	359800320	0.00
22	1/2	90	33	46	15	22	27	198102022UNW	10	100	359800330	0.00
22	3/4	90	38	46	19	22	30	198304022UNW	10	100	359800340	0.00
28	1	90	48	51	21	27	40	198100028UNW	5	50	359800350	0.00
											3598	

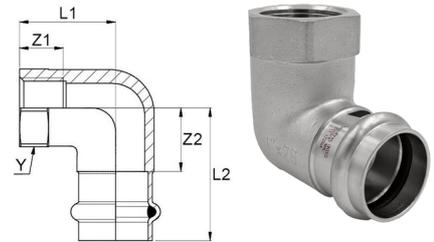

**Übergänge INOXPRES Uniko 304L 269/M NW Inox M/V-Profil**

- Aussengewinde mit Einschubende
- Material: AISI 316L - 1.4404
- Gewindenorm: EN 10226-1 (ex ISO 7/1)

d mm	AG (R) Zoll	L mm	Z mm	Y mm	Orig. Nr.	Stück	Stück	Art.-Nr.	CHF Stück
15	1/2	52	31	22	269102115NW	20	300	359801380	0.00
18	1/2	52	31	22	269102118NW	20	300	359801390	0.00
22	3/4	56	32	27	269304122NW	10	200	359801400	0.00
28	1	64	37	38	269100128NW	10	100	359801410	0.00
									3598

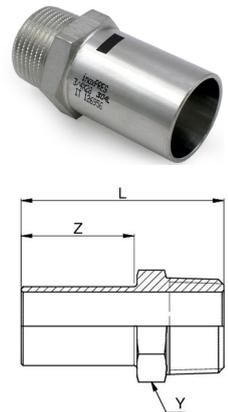

**Übergänge INOXPRES Uniko 304L 269/F NW Inox M/V-Profil**

- Innengewinde mit Einschubende
- Material: AISI 316L - 1.4404
- Gewindenorm: EN 10226-1 (ex ISO 7/1)

d mm	IG (Rp) Zoll	L mm	Z mm	Y mm	Orig. Nr.	Stück	Stück	Art.-Nr.	CHF Stück
15	1/2	52	31	24	269102015NW	20	300	359801420	0.00
18	1/2	52	31	24	269102018NW	20	200	359801430	0.00
22	1/2	52	32	24	269102022NW	10	200	359801440	0.00
22	3/4	52	32	30	269304022NW	10	200	359801450	0.00
28	3/4	57	37	30	269304028NW	10	150	359801460	0.00
28	1	57	35	36	269100028NW	10	100	359801470	0.00
									3598

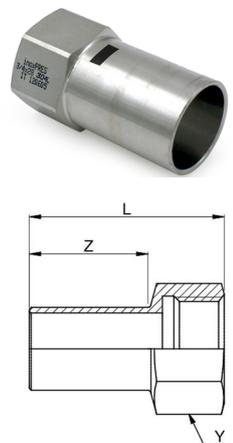

INOXPREES 304L



**Übergangsflansche INOXPREES Uniko 304L 193/000 UNW Inox M/V-Profil**

- Material 1: AISI 304L - 1.4307
- O-Ring: EPDM schwarz
- PN 16

d	DN flg	H	Z	B	D	D2	Lochanzahl	K	Orig. Nr.	Stück	Art.-Nr.	CHF	
mm	mm	mm	mm	mm	mm	mm	Stück	mm		Stück		Stück	
22	20	61.5	37.5	16	105	14	4	75	193022000UNW	2	14	359801850	0.00
28	25	63	39	16	115	14	4	85	193028000UNW	2	10	359801860	0.00
35	32	65.5	37.5	16	140	18	4	100	193035000UNW	2	6	359801870	0.00
42	40	75	39	16	150	18	4	110	193042000UNW	2	6	359801880	0.00
54	50	82.5	41.5	16	165	18	4	125	193054000UNW	2	4	359801890	0.00
												3598	

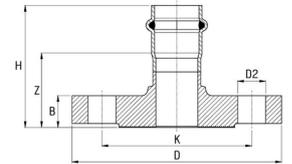

INOXPREES 304L



**Übergangsflansche INOXPREES 193/000 NW King Size Inox M-Profil**

- Material 1: AISI 304L - 1.4307
- O-Ring: EPDM schwarz
- PN 16

De	DN flg	H	Z	B	D	D2	Lochanzahl	K	Orig. Nr.	Stück	Art.-Nr.	CHF
mm	mm	mm	mm	mm	mm	mm	Stück	mm		Stück		Stück
76.1	65	105	50	18	185	18	4	145	193076000NW	2	358800520	276.50
88.9	80	116	56	20	200	18	8	160	193088000NW	2	358800530	330.00
108	100	132	57	20	220	18	8	180	193108000NW	2	358800540	393.00
												3588

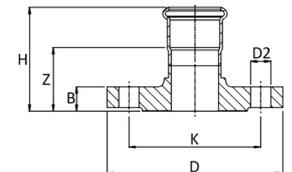

INOXPREES 304L



**Übergangsflansche INOXPREES 193/001 NW King Size Inox M-Profil**

- Material: AISI 304L - 1.4307
- Material 2: AISI 304 - 1.4301
- O-Ring: EPDM schwarz
- PN 10

De	DN flg	H	Z	B	D	D2	Lochanzahl	K	Orig. Nr.	Stück	Art.-Nr.	CHF
mm	mm	mm	mm	mm	mm	mm	Stück	mm		Stück		Stück
76.1	65	86.5	31.5	23.5	185	18	4	145	193076001NW	2	358800490	141.50
88.9	80	96	36	23.5	200	18	8	160	193088001NW	2	358800500	166.00
108	100	116	41	24	220	18	8	180	193108001NW	2	358800510	183.50
												3588

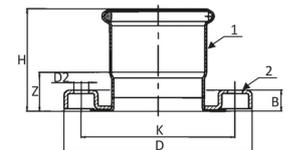

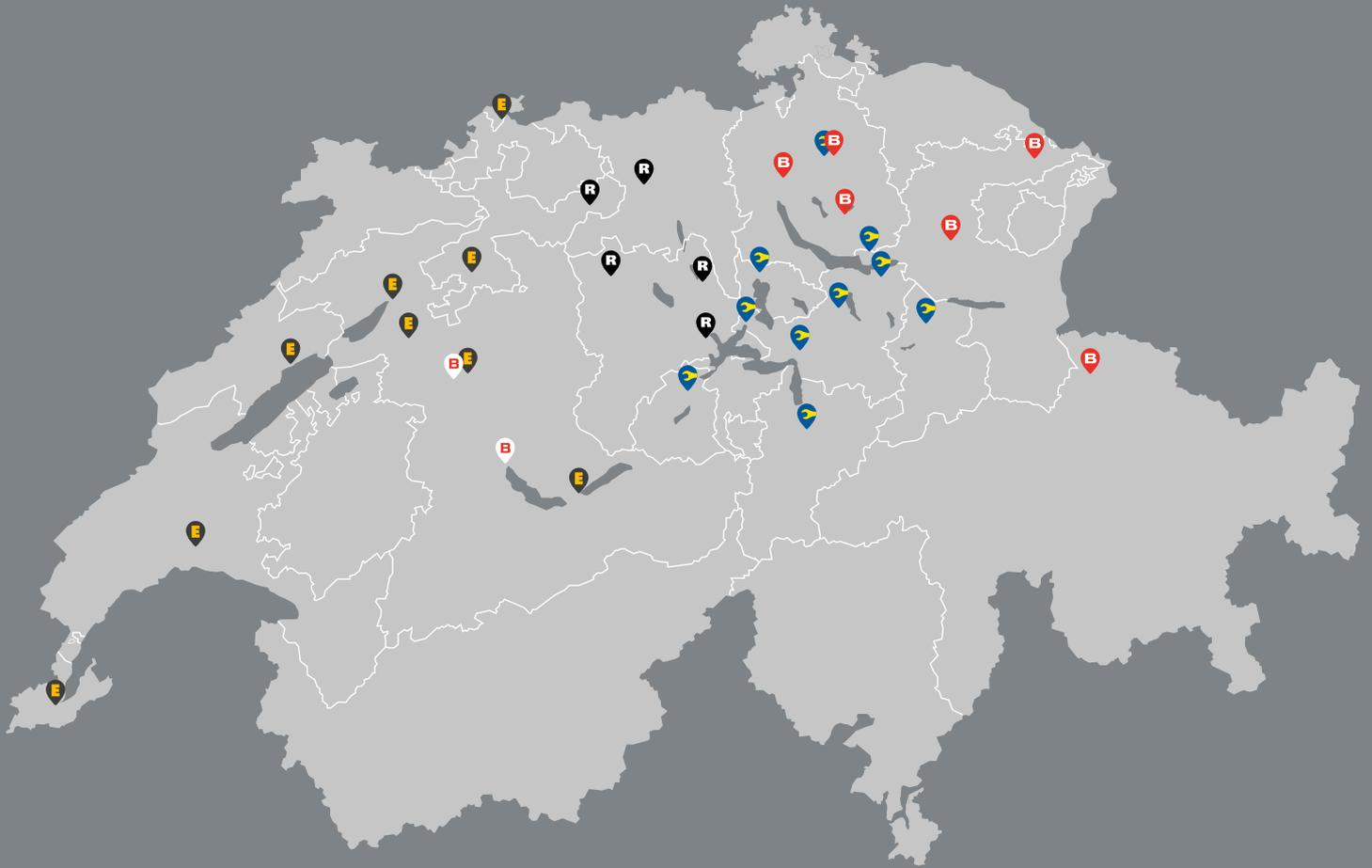

**ARTHUR WEBER AG**

haustechnik@arthurweber.ch  
041 819 06 61

- Seewen
- Schattdorf
- Küssnacht
- Einsiedeln
- Galgenen
- Steinhausen
- Jona
- Alpnach



**BRINER**

haustechnik@brinerag.ch  
052 234 24 44

- Winterthur
- Wetzikon
- Glattbrugg
- Landquart
- St. Gallen
- Wattwil



**REKAG**

haustechnik@rekag.ch  
062 748 33 33

- Nebikon
- Kriens
- Hochdorf
- Oberentfelden
- Olten



**B TEAM**

info@bteam.ch  
031 384 20 40

- Bern
- Thun



**ENGEL**

verkauf.haustechnik@engel.ch  
032 346 16 16

- Biel/Bienne
- Lyss
- Bern
- Solothurn
- Interlaken
- Basel
- Neuchâtel
- Lausanne
- Genève



RACCORDERIE METALLICHE

**IHRE PARTNER FÜR  
HAUSTECHNIK!**